



Aladin ONE
User manual

deep down you want the best

scubapro.com

I Safety considerations

WARNING

You must carefully read and understand this entire manual before using your Scubapro Aladin ONE.

Diving has many inherent risks. Even if you follow the instructions of this manual in a careful manner, it is still possible that you may be seriously injured or die from decompression sickness, oxygen toxicity or some other inherent risk of scuba with Nitrox or compressed air. Unless you are fully aware of these risks and are willing to personally accept and assume responsibility for those risks, do not use Scubapro Aladin ONE.

Guidelines for the use of ONE

The following guidelines for using ONE are derived from the latest medical research and the recommendations of the American Academy of Underwater Sciences for diving with diving computers. Following these guidelines will greatly increase your safety while diving, but cannot guarantee that decompression sickness or oxygen toxicity will not occur.

- ONE is designed for dives with compressed air (21% O₂) and Nitrox (22 to 50% O₂) only. Do not use ONE for dives made with other mixed gases.
- It is absolutely necessary to check the set mixture before each dive and to compare it to the gas mixture currently used. Always remember: setting an incorrect mixture carries an inherent risk of decompression sickness and/or oxygen toxicity! Maximum deviation from the measured mixture must not exceed 1% O₂. An incorrect gas mixture can be lethal!
- Only use ONE with open circuit breathing systems.
- Only use ONE for diving with an independent breathing apparatus. ONE is not designed for long term exposures with Nitrox.
- Always observe the visual and audible alarm signals. Avoid situations of increased risk which are marked with a warning sign in this operating manual.
- ONE has a ppO₂ warning. The default limit is set at 1.4bar ppO₂max. It can be changed between 1.2 and 1.6bar.
- Frequently check the "oxygen clock" (CNS O₂). Ascend and finish the dive if the CNS O₂ exceeds 75%.
- Never dive deeper than the Maximum Operating Depth (MOD) pertinent to the gas mixture in use.
- Always check the diving limits considering the oxygen content and standard sports diving procedures (decompression sickness, oxygen toxicity).
- In accordance with the recommended maximum diving limit of all instructional agencies, do not dive deeper than 40 metres/130 feet.
- The danger of nitrogen narcosis has to be taken into consideration. ONE gives no warning about this.
- On all dives, with or without dive computer, make a safety stop for at least 3 minutes at 5 metres (15 feet).
- All divers using dive computers to plan dives and indicate or determine decompression status must use their own computer, which they take with them on all dives.
- If ONE fails at any time during the dive, the dive must be terminated, and appropriate surfacing procedures (including a slow ascent and a 3 to 5 minute safety stop at 5m /15ft) should be initiated immediately.
- Comply with the ascent rate and carry out any decompression stop required. If the computer should fail for any reason, you must ascend at a rate of 10m / 30ft per minute or less.
- On any given dive, both divers in a buddy pair must follow the most conservative dive computer for that particular dive.
- Never dive without a buddy. ONE does not substitute for a dive buddy.
- Only make dives that are appropriate to your level of dive training. ONE does not increase your knowledge of diving.

- Always dive with back-up instruments. Make sure that you always use back-up instrumentation including a depth gauge, submersible pressure gauge, digital bottom timer or dive watch, and have access to decompression tables whenever diving with a dive computer.
- Avoid repeated ascents and descents (yo yo diving).
- Avoid repeated heavy workload while at depth.
- Plan the dives to be shorter if they are made in cold water.
- After finishing the decompression or at the end of a no-stop dive, the final stage of the ascent should be as slow as possible.
- You **MUST** be familiar with all signs and symptoms of decompression sickness before using ONE! Seek **IMMEDIATE** treatment for decompression sickness should any of these signs or symptoms occur after a dive! There is a direct correlation between the effectiveness of treatment and the delay between the onset of symptoms and the treatment for decompression sickness.
- Only dive with Nitrox after you have been thoroughly instructed by a recognised institution.

Repetitive dives

- Do not start your next dive before your CNS O₂% status has dropped below 40%.
- When diving with Nitrox, make sure your surface interval is long enough (just like diving with compressed air). Plan for a minimum surface interval of two hours. Oxygen, too, needs sufficient time to leave the body.
- Match gas mixture to the intended dive.
- Do not attempt a repetitive dive if the no-dive warning  is visible on the display.
- Plan a day without diving once a week.
- If you have to change computers, wait at least 48 hours before carrying out your next dive.
- Diving after a reset of the remaining saturation (reset, see page 33, or battery replacement, see page 37) may lead you into potentially hazardous situations which could result in death or serious injury. After a reset of the remaining saturation do not dive for at least 48 hours.

Altitude and diving

- Do not dive at altitudes higher than 4000m (13000ft).
- After a dive do not rise to altitudes that ONE prohibits via the flashing altitude range number (see page 27).



Flying after diving

- After diving, wait at least 24 hours prior to flying.



Aladin ONE dive instrument is compliant with the European Union directive 2004/108/EC.

Standard EN 13319: 2000

Aladin ONE dive instrument is also compliant with the European standard EN 13319: 2000 (EN 13319: 2000 – Depth gauges and combined depth and time measuring devices – Functional and safety requirements, tests methods).

Introduction

Congratulations on purchasing ONE and welcome to Scubapro. From now on you will enjoy the assistance of an extraordinary dive computer - equipped with Scubapro innovative technology - while diving.

We thank you for choosing ONE and we hope you will enjoy safe dives in the future! Further information on Scubapro and Scubapro products can be found on our web page at www.scubapro.com.

To make this manual easier to read we will use the term "ONE" as an abbreviation for "Aladin ONE diving computer" throughout this booklet.

Safety considerations

Dive computers provide divers with data; they, however, do not provide the knowledge how this data should be understood and applied. Dive computers cannot replace common sense! You must therefore carefully read and understand this entire manual before using your ONE.

Important remarks concerning signal words and symbols

This operating manual makes use of the following icons to indicate especially important comments:



Remarks Information and tips which are important for optimal use of the functions of ONE.



Danger! Indicates a potentially hazardous situation which, if not avoided, could result in death or serious injury.

The following symbols are used in the operating manual:



Flashing display -> Page reference e.g. ->6

Audible signals

))) 4s))) Audible attention signal

)))))) Audible alarm signal

Instructions for manual input

- Press left push button
- Press and hold (1 second) left push button
- Press right push button
- Press and hold (1 second) right push button
- Press and hold (1 second) both push buttons

Alternate displays

By pushing during the dive you can scroll through alternate displays.

How to get back to the first display:

- scrolling with through the displays
- after 5 seconds: automatically if marked with
- after 5 seconds: directly by pushing 1x

E.g. Max depth > Temperature > Temperature, Time > Max depth

- Time out after 5 seconds without operation. Display switches back to original indication.

Quick reference

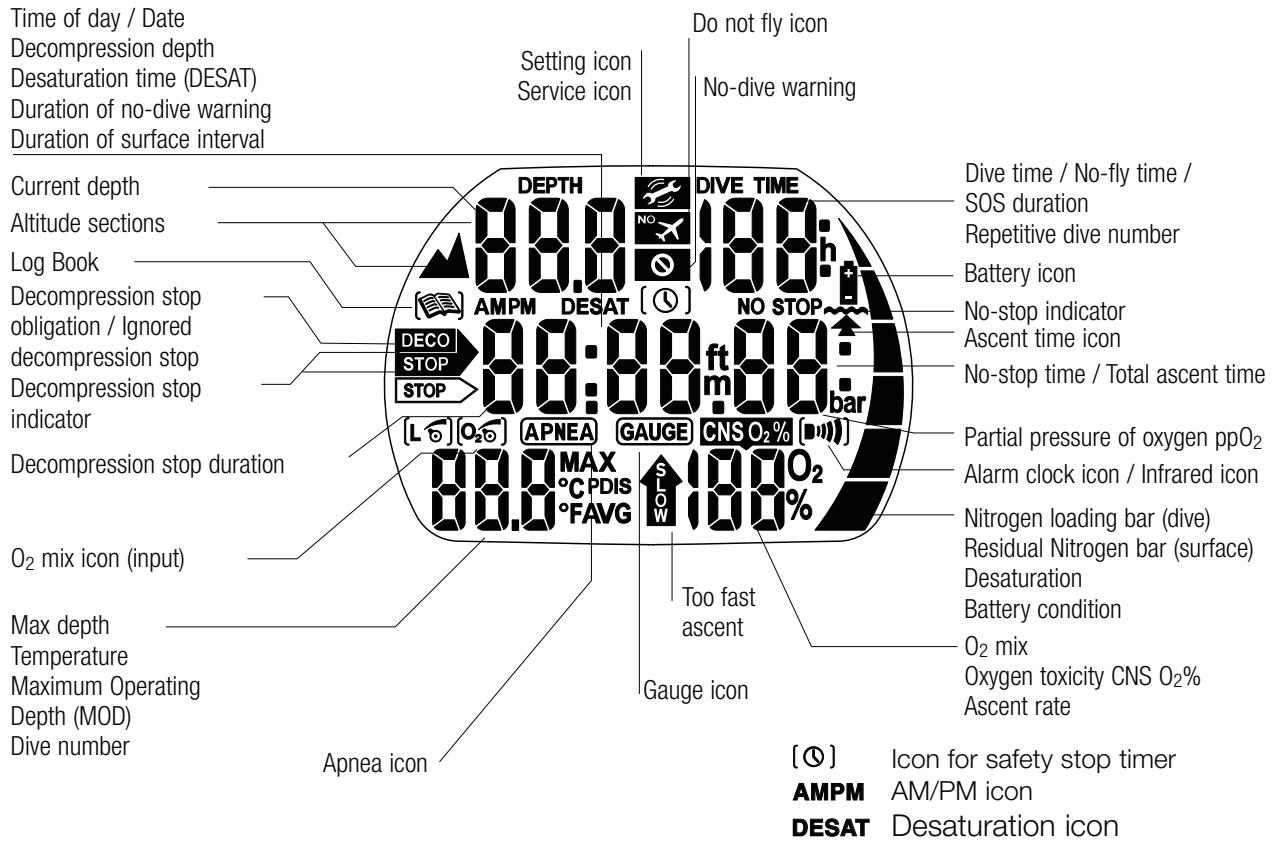

Operating scheme

"->" means "more information at page"

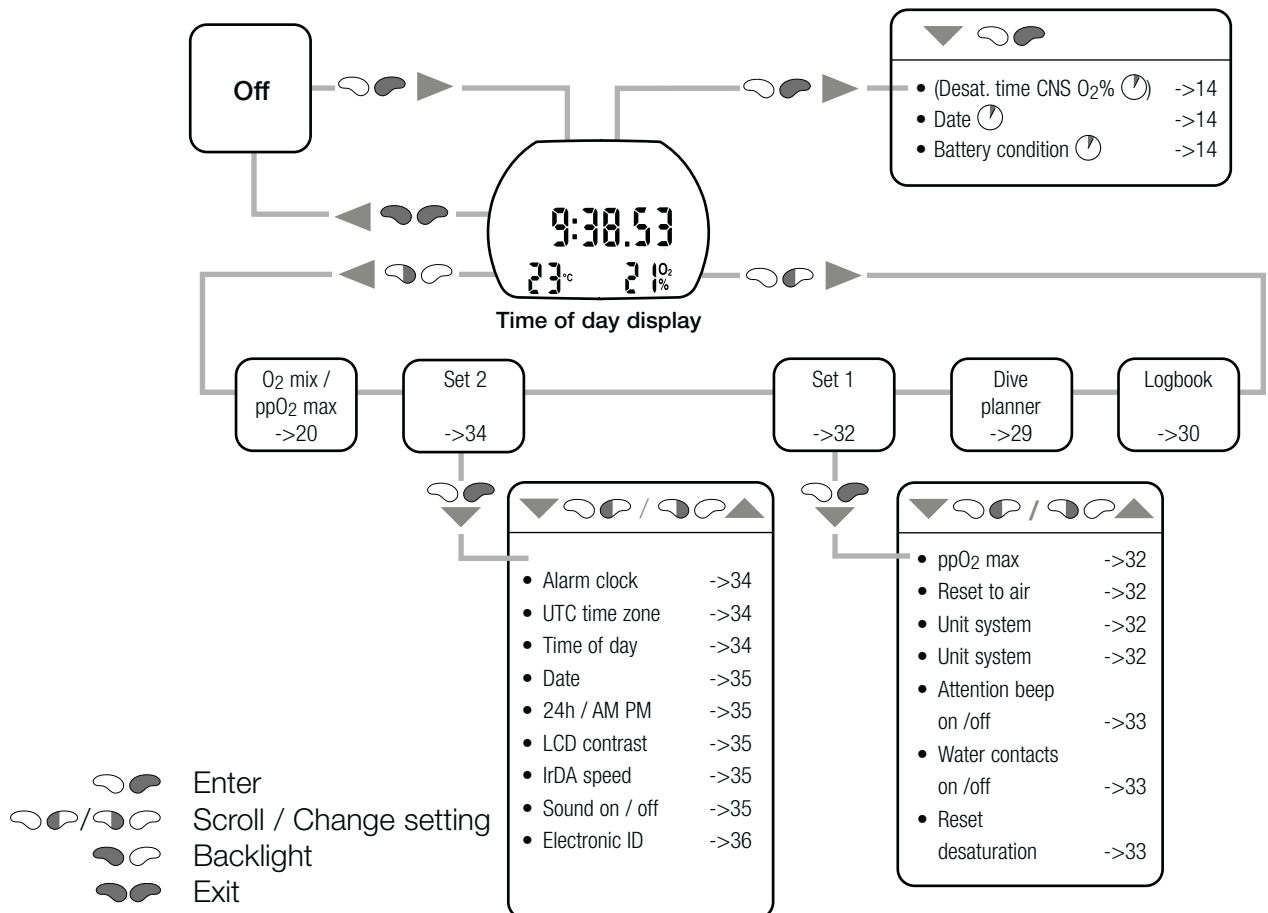

Without operation the display switches automatically back to the time of day display and after 3 minutes the display switches off.
See also page 13.

Display switched off



<p>O₂ mix [0.16]</p>		<p>Logbook </p>	<p>Diveplanner (PLn)</p>
<div style="border: 1px solid black; padding: 5px; margin-bottom: 5px;"> </div> <div style="border: 1px solid black; padding: 5px; margin-bottom: 5px;"> <p>21% Oxygen concentration </p> <p> </p> </div> <div style="border: 1px solid black; padding: 5px; margin-bottom: 5px;"> <p>1.40 ppO₂ max (MOD) </p> <p> </p> </div> <div style="border: 1px solid black; padding: 5px;"> <p> Confirmation</p> </div>	<div style="border: 1px solid black; padding: 5px; margin-bottom: 5px;"> <p>Page 1</p> <p>Max depth — 28.9 35 — Dive time</p> <p>09.02.04 — Battery performance</p> <p>Date of the dive — 1 — 21% — O₂ mix.</p> <p> Dive </p> <p> number </p> </div> <div style="border: 1px solid black; padding: 5px; margin-bottom: 5px;"> <p>Page 2</p> <p>Altitude range (if >0) — 2 — 1 — Repetitive divenumber</p> <p>10:32:50 — Starting time</p> <p>Minimum temperature — 25°C — 8% — CNS O₂% at the end</p> </div> <div style="border: 1px solid black; padding: 5px; margin-bottom: 5px;"> <p>Page 3</p> <p>SOS if applicable — SOS Int — Surface interval if applicable</p> <p>2:35</p> </div> <div style="border: 1px solid black; padding: 5px;"> <p> Exit</p> </div>	<div style="border: 1px solid black; padding: 5px; margin-bottom: 5px;"> <p> Surface interval </p> <p> </p> </div> <p>No-stop dive</p> <div style="border: 1px solid black; padding: 5px; margin-bottom: 5px;"> <p>Add — No-stop time</p> <p>300 MAX — 16: —</p> <p> Depth </p> <p> </p> </div> <div style="border: 1px solid black; padding: 5px;"> <p> Exit</p> </div>	
<p>After the oldest dive:</p> <p>Statistic information</p> <p>Deepest dive — 28.9 26. — Longest dive</p> <p>Number of dives — 53 — 23 h — Cumulative bottom time</p>			

I	Safety considerations	2
	Introduction	4
	Important remarks concerning signal words and symbols	4
	Quick reference / Operating scheme	5
	List of chapters	7
II	System and operation	9
1	System description	9
2	Operation.....	9
	2.1 Push buttons.....	9
	2.2 Water contacts	10
	2.3 Introduction to Scubapro LogTRAK.....	10
	2.4 Switching on the display.....	13
	2.5 How to navigate ONE at the surface	13
	2.6 Checking the desaturation time.....	14
	2.7 Checking the surface interval	14
	2.8 Displaying the date	14
	2.9 Checking the battery condition.....	14
	2.10 Active backlight.....	15
	2.11 Switching off the display.....	16
	2.12 Alarm clock	16
3	SOS mode.....	16
III	Diving with ONE	17
1	Terminology / Symbols.....	17
	1.1 General terminology / Display during no-stop phase	17
	1.2 Display during decompression phase	17
	1.3 Nitrox information (O ₂ information).....	18
2	Attention messages and alarms	19
	2.1 Attention messages.....	19
	2.2 Alarms.....	19
3	Preparation for the dive.....	20
	3.1 Setting the gas mixture and ppO ₂ max.....	20
	3.2 Preparation for the dive and function check	20
4	Functions during the dive	21
	4.1 Immersion	21
	4.2 Dive time	21
	4.3 Current depth / O ₂ % mix.....	21
	4.4 Maximum depth / Temperature	21
	4.5 Ascent rate.....	22
	4.6 Partial pressure of oxygen (ppO ₂ max) / Maximum Operating Depth (MOD).....	23
	4.7 Oxygen toxicity (CNS O ₂ %)	23
	4.8 Nitrogen loading bar graph.....	24
	4.9 Decompression information.....	24
	4.10 Safety stop timer	26
5	Functions at the surface.....	26
	5.1 End of a dive.....	26
	5.2 Residual nitrogen bar graph	26
	5.3 Desaturation time, No-fly time and No-dive warning.....	26
6	Diving in mountain lakes.....	27
	6.1 Altitude ranges	27
	6.2 Prohibited altitude	28
	6.3 Decompression dives in mountain lakes.....	28

IV Dive planner.....	29
1 Planning a no-stop dive	29
2 Leaving the dive planner	29
V Logbook.....	30
1 Survey.....	30
2 Operation.....	30
VI Settings.....	32
1 Menu "set 1"	32
2 Menu "set 2"	34
VII Appendix.....	36
1 Technical information	36
2 Maintenance	36
2.1 Replacing the battery (Battery kit includes battery and Teflon coated o-ring).....	37
3 Warranty	39
4 Index.....	40

II System and operation

1 System description

ONE displays all important dive and decompression data and has a memory which stores the full dive data. The data can be transmitted with an infrared interface (IrDA) and LogTRAK software to a Windows® personal computer.

LogTRAK software CD is included with the ONE package. Infrared interfaces are available in PC.

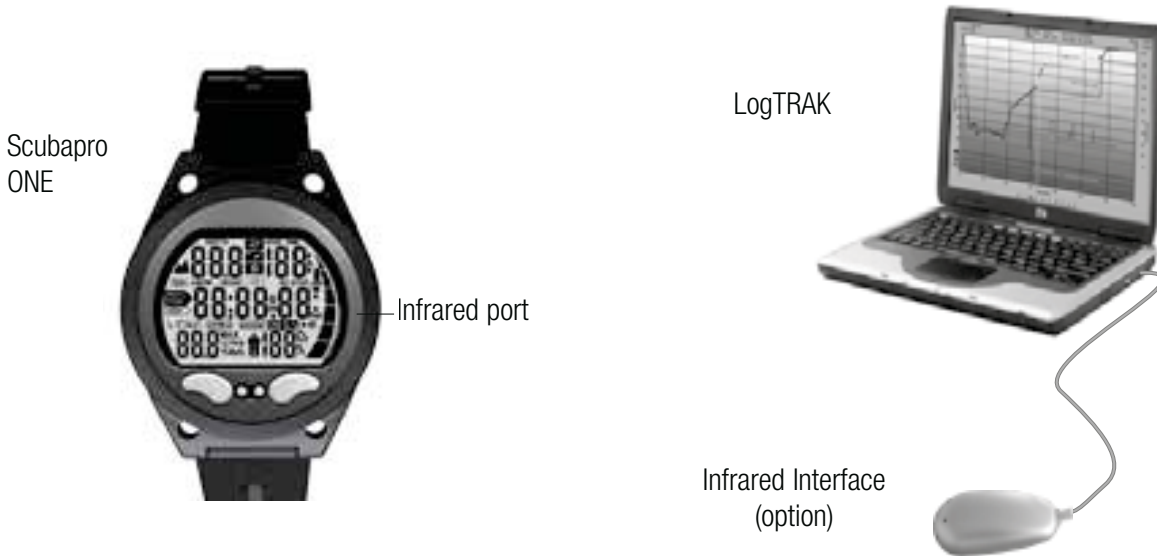

2 Operation



On page 5 and 13 you will find an operating schematic.

2.1 Push buttons

ONE can be operated with two push buttons (☞☞). Operation of the push buttons is divided into "press" (☞ / ☞) and "press and hold (1 second)" (☞☞/☞☞).

At the surface:



Push buttons

Water contacts (one located in front and one on back, however, inaccessible)



- Switch on ONE (**time of day display**)
- Comparable to the ENTER or RETURN key of a keyboard
- Enter into the displayed sub menu
- Open the displayed setting
- Confirm or enter the displayed value or setting
- Scroll through a menu
- Once entered with ☞☞ into a sub menu or setting:
 - Increase (☞☞) or decrease (☞☞) the indicated value
 - Change the setting
- Switch on the backlight
- Exit the current function or menu and switch to the **time of day display**
- Switch off ONE

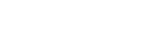

Under water:



- Access alternate displays ☞☞
- Switch on the backlight
- Activate the safety stop timer (dive mode only, in depths < 6.5m / 21ft)

2.2 Water contacts

On submerging in water the water contacts switch on ONE automatically.

! WARNING

If you have chosen the option "Water contacts off" ("set 1", ->33), ONE will turn on with a delay of up to 1 minute into the dive. This will affect functioning of the computer. Make sure that the computer is on before starting the dive.

2.3 Introduction to Scubapro LogTRAK

LogTRAK is the software that allows Aladin ONE to communicate with a Windows-based PC or Mac OS.

In order to take advantage of any of these features, you need to establish a communication between your PC and Aladin ONE with a dongle.

To start the communication

1. Connect the dongle to your PC
2. Launch LogTRAK on your PC
3. Select the IrDa port where the dongle is connected
Extras -> Options -> download



4. Place the Aladin ONE on the dongle.

Download dive profiles

From LogTRAK, by selecting Dive -> Download Dives you can transfer the ONE Logbook to your PC or Mac.

There are three main views each showing a specific part of your dive logs:

Profile shows the graphical data of the dive.

Details about the dive, where you can edit, for example, the equipment and tank information.

Location, shows your dive site on the world map.

The selection tabs for views are on the left side of the main window.

My Logbook - SCUBAPRO LogTRAC

Logbook Dive Extra About Help

No. 10 Date: Aug 26, 2014 Start time: 12:32 PM Duration: 58min Max depth: 14.8m

No.	Location / Spot	Date	Start Time	Duration	End time	Max depth
10	Maui / Molokai Coast	Aug 26, 2014	12:32 PM	0:58	2:04 PM	14.8
11	Maui / Molokai Coast	Aug 26, 2014	11:35 AM	0:37	12:15 PM	11.4
12	Maui / Molokai Coast	Aug 26, 2014	10:31 AM	0:22	10:53 AM	12.2
13	Maui Big Island / Molokai Bay	Aug 26, 2014	10:30 AM	0:31	11:15 AM	11.4
14	Maui Big Island / Night Reef	Aug 19, 2014	3:15 PM	1:01	4:23 PM	10.2

My Logbook - SCUBAPRO LogTRAC

Logbook Dive Extra About Help

No. 12 Date: Aug 27, 2014 Start time: 11:18 AM Duration: 52min Max depth: 11.4m

Rating ★★★★☆ 4

Interval 18.27 min

Avg. Depth 10.0 m

Max. heart rate 137 bpm

Max. heart rate 140 bpm

Avg. heart rate 75 bpm

Computer

Computer:

Dive mode:

Altitude:

Alt level:

Sub:

Salt:

Weight:

Task

DU:

Start pressure:

End pressure:

Number:

Comments

Excellent - just great to dive that amazing water! Saw a small shark as well.

No.	Location / Spot	Date	Start Time	Duration	End time	Max depth
12	Maui / Molokai Coast	Aug 27, 2014	11:18 AM	0:52	2:04 PM	11.4
13	Maui / Molokai Coast	Aug 27, 2014	11:18 AM	0:37	12:15 PM	11.4
14	Maui Big Island / Molokai Bay	Aug 26, 2014	10:30 AM	0:29	10:50 AM	11.4
15	Maui Big Island / Molokai Bay	Aug 26, 2014	12:51 PM	1:08	2:00 PM	16.6
16	Maui Big Island / Molokai Bay	Aug 26, 2014	10:55 AM	1:01	11:56 AM	15.4
18	Maui Big Island / Night Reef	Aug 19, 2014	3:15 PM	1:01	4:23 PM	10.2

My Logbook - SCUBAPRO LogTRAC

Logbook Dive Extra About Help

No. 11 Date: Aug 25, 2014 Start time: 11:28 AM Duration: 57min Max depth: 11.4m

Dive Spot

Location:

Spot:

Latitude:

Longitude:

Weather conditions

Weather:

Water

Max. temp:

Min. temp:

Visibility:

No.	Location / Spot	Date	Start Time	Duration	End time	Max depth
11	Maui / Molokai Coast	Aug 25, 2014	11:28 AM	0:57	2:04 PM	11.4
12	Maui / Molokai Coast	Aug 27, 2014	11:18 AM	0:37	12:15 PM	11.4
13	Maui / Molokai Coast	Aug 27, 2014	10:31 AM	0:22	10:53 AM	12.2
14	Maui Big Island / Molokai Bay	Aug 26, 2014	10:30 AM	0:29	10:50 AM	11.4
15	Maui Big Island / Molokai Bay	Aug 26, 2014	12:51 PM	1:08	2:00 PM	16.6
16	Maui Big Island / Molokai Bay	Aug 26, 2014	10:55 AM	1:01	11:56 AM	15.4
18	Maui Big Island / Night Reef	Aug 19, 2014	3:15 PM	1:01	4:23 PM	10.2

Change warnings/settings of the ONE and reading the computer information

By selecting Extras -> Read Dive Computer settings you can enable/disable warnings that cannot be enabled or disabled by using the menus on the ONE unit.



Read the chapter Warnings and alarms about the possible selections that you can modify on your ONE. You may also change the shown units between metric/imperial. Select Extras -> Options -> measurement units:

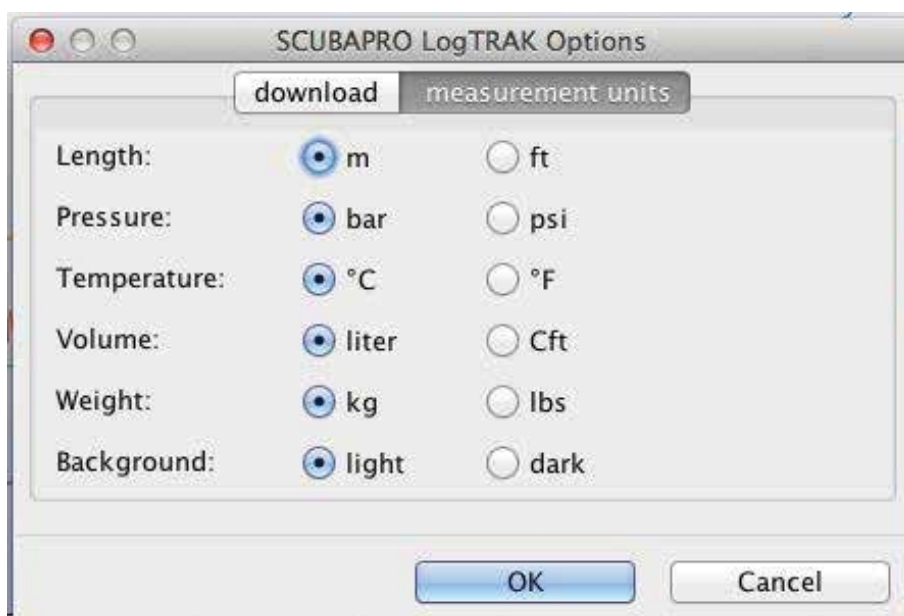

2.4 Switching on the display

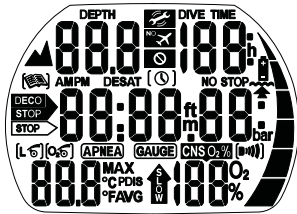

Time of day display

- automatically, on submerging in water* or when adaptation to atmospheric pressure is necessary;
- manually, by pushing or . If switched on with all segments light up for 5 seconds. Afterwards the display shows the time of the day, the O₂ mix and the temperature.



This display is called **time of day display**. Most navigation descriptions start from this display. At the surface ONE returns automatically to this display.

If there is a remaining saturation from the last dive or from a change of altitude, ONE also displays the "do not fly" time, the "do not fly" icon, the current altitude range and the prohibited altitude range (->26).



When ONE is in state of rest no information is displayed but the atmospheric pressure is continuously monitored. If a change in altitude range is detected, ONE switches on for 3 minutes automatically ->27.

* Only if the option "Water contacts on" ("set 1", ->33) is chosen. See warning ->10.

2.5 How to navigate ONE at the surface

Starting from the **time of day display** you can enter into different menus.

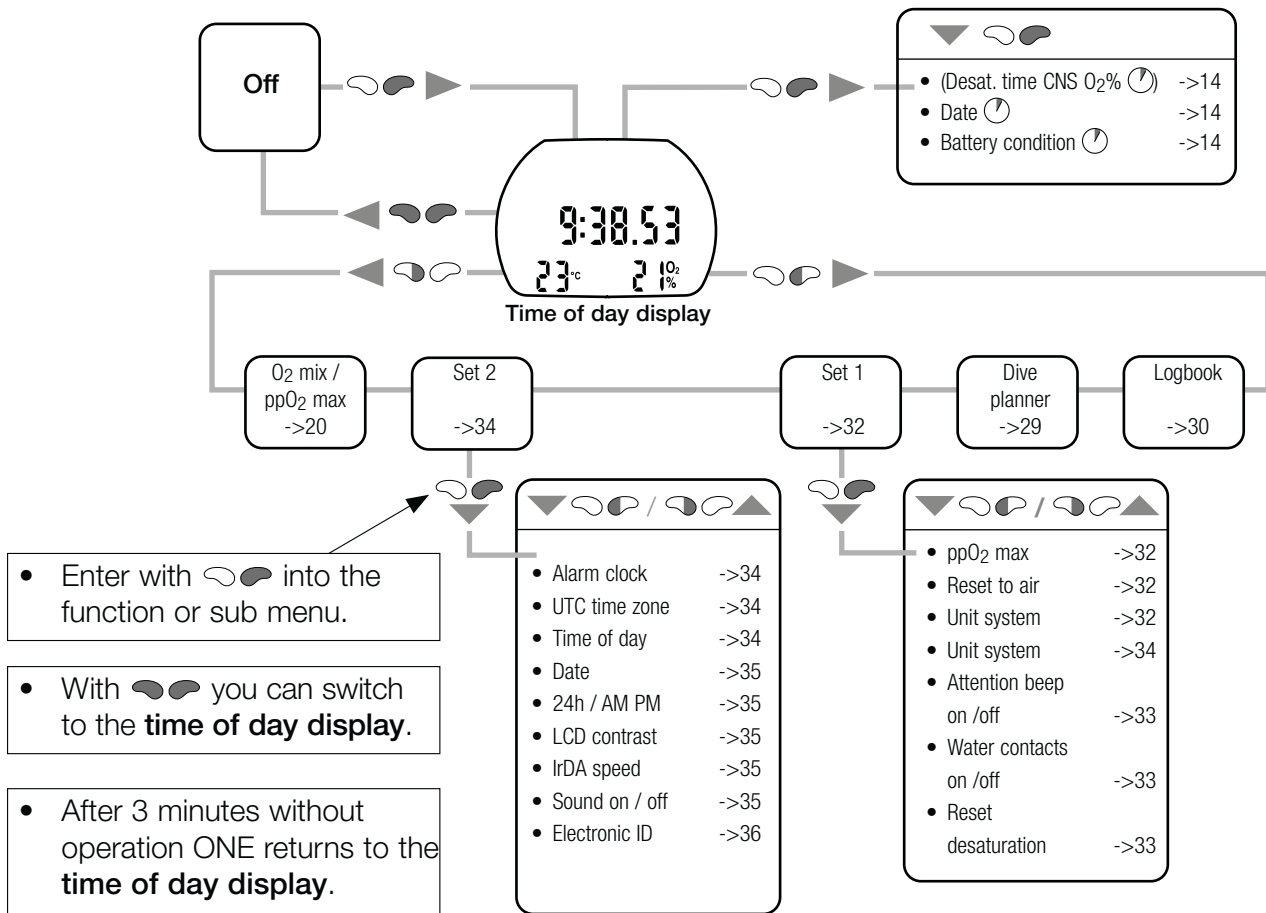

2.6 Checking the desaturation time

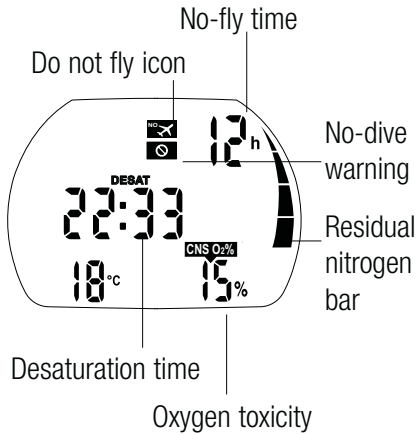

From the **time of day display** you can check the desaturation time* by pushing . Desaturation time is determined either by oxygen toxicity, nitrogen saturation or the regression of microbubbles, depending on which requires the longer time.

The display switches back to the time of day display after 5 seconds without operation.

* Only displayed if there is a remaining saturation due to the last dive or change of altitude.

! WARNING

For the calculations of the desaturation and no-fly time it is assumed that the diver breathes air while on the surface.

2.7 Checking the surface interval

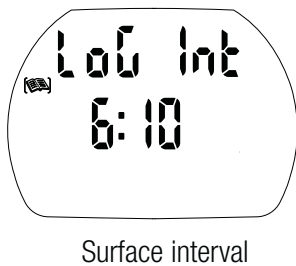

From the **time of day display** you can check the surface interval by pushing (logbook menu).

The surface interval is the time since the end of the last dive and is displayed as long as there is remaining saturation.

2.8 Displaying the date



From the **time of day display** you can display the date by pushing 1x or 2x (depending on whether there is desaturation time left).

The display switches back to the **time of day display** after 5 seconds without operation.

2.9 Checking the battery condition

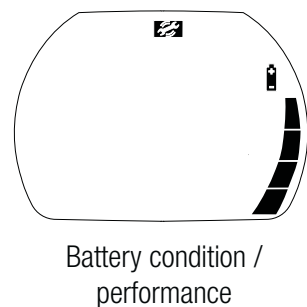

From the time of day display you can check the battery condition by pushing 2x or 3 x (depending on whether there is desaturation time left).

ONE displays the estimated remaining battery performance for 5 seconds as a bar graph. If the bar graph shows 3 segments the battery warning appears ->15 and the battery has to be replaced ->37.

! WARNING

- If the bar graph shows 2 segments, the battery symbol will blink, on the surface and in dive mode, to alert the diver of a dangerous situation: the battery may not have enough energy to finish a dive.
- Replace the battery when the steady battery symbol appears (3 segments)!



The temperature influences the battery performance. In cold water it is lower than in warm water. If the battery shows 4 segments on the surface, it is possible for it to drop to 3 segments during the dive. If this is the case, the backlight will be temporarily disabled. See below.

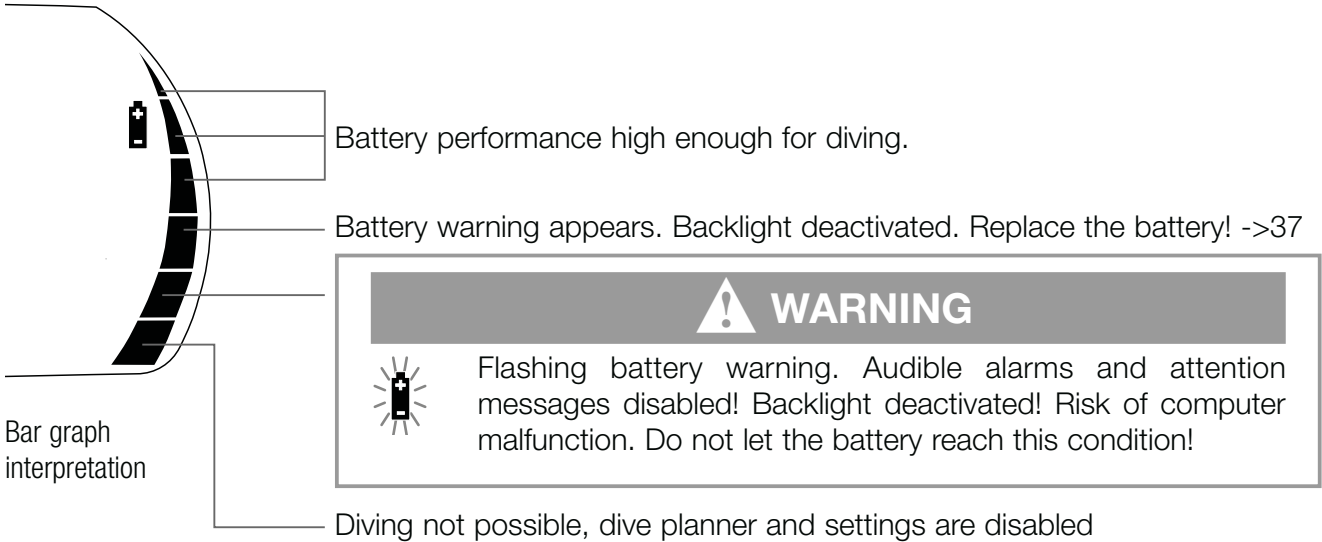

ONE marks dives started with 3 or less segments in the logbook with the battery symbol. Logbook information is not lost even when the battery is removed for a long time.

2.10 Active backlight



The display of ONE can be illuminated both on the surface and underwater. The backlight can be activated by pushing . The light will turn off automatically after 6 seconds. The backlight can only be activated if the computer display is on.





Repeated activation of the backlight will reduce battery life.

2.11 Switching off the display

From the **time of day display** you can switch off ONE by pushing . On the surface ONE switches off automatically after 3 minutes without operation.

2.12 Alarm clock

The alarm clock goes off only at the surface. If the alarm clock is "on", the time of day display shows .

When alarm is triggered:  flashes and special attention beeps are played for 30 seconds or until the user presses a button.

Setting the alarm clock: ->34 ("set 2")

3 SOS mode

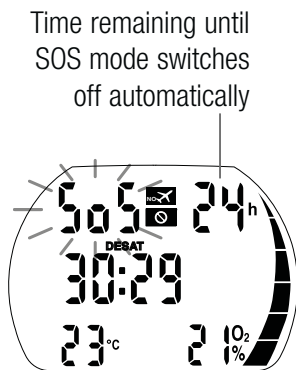

Activation: automatic

If the diver remains above a depth of 0.8m (3ft) for more than three minutes without observing a prescribed decompression stop, the computer will automatically switch into SOS mode after the dive.

Push  to see the "SOS" sign and the remaining length of the SOS mode. The dive will be entered in the logbook with "SOS".

The SOS mode will be unlocked after 24 hours.

While in SOS mode, the computer cannot be used for diving.

Diving within 48 hours after the end of an SOS mode will result in shorter no stop times or longer decompression stops.

WARNING

- Serious injury or death may result if a diver does not seek immediate treatment should any signs or symptoms of decompression sickness occur after a dive.
- Do not dive to treat symptoms of decompression sickness!

III Diving with ONE

1 Terminology / Symbols

The information on the display of ONE varies depending on the kind of dive and the dive phase.

1.1 General terminology / Display during no-stop phase

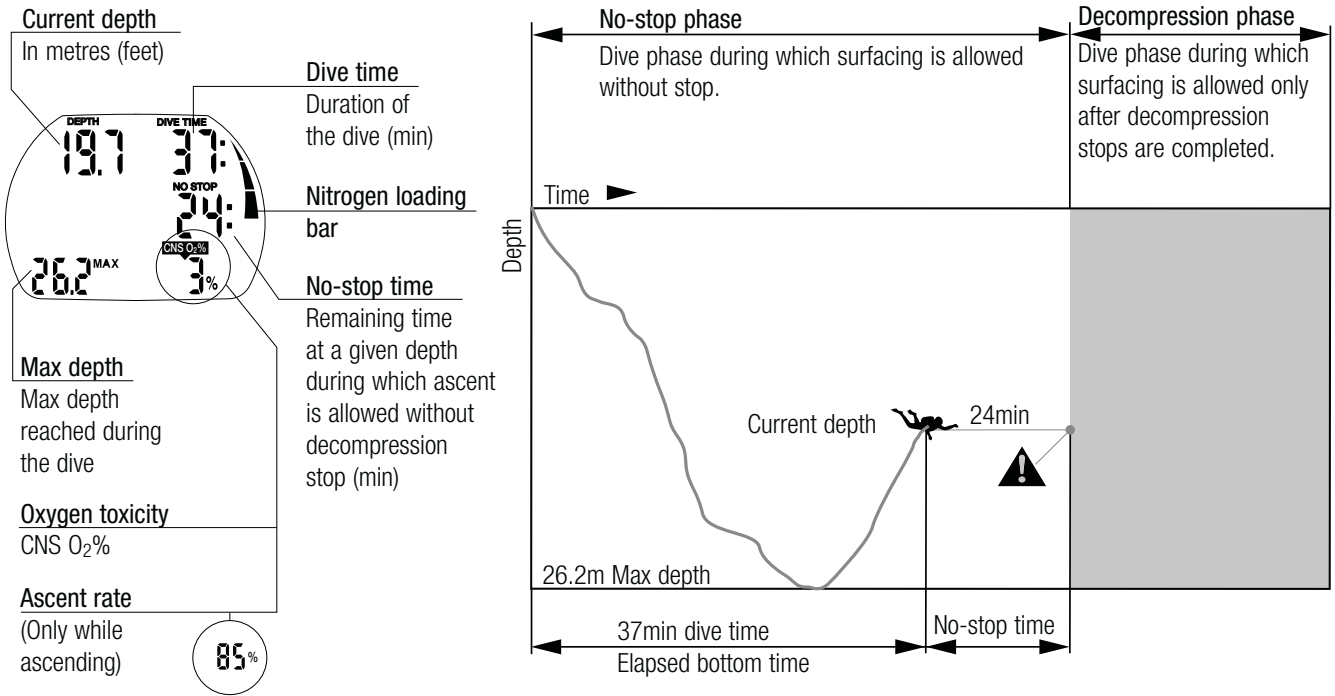

- ☺ (Max depth ☺ >) Temperature
- ☺ > Temperature ☺, O₂ mix ☺ and time of day ☺
- ☺ > (Max depth)...

1.2 Display during decompression phase

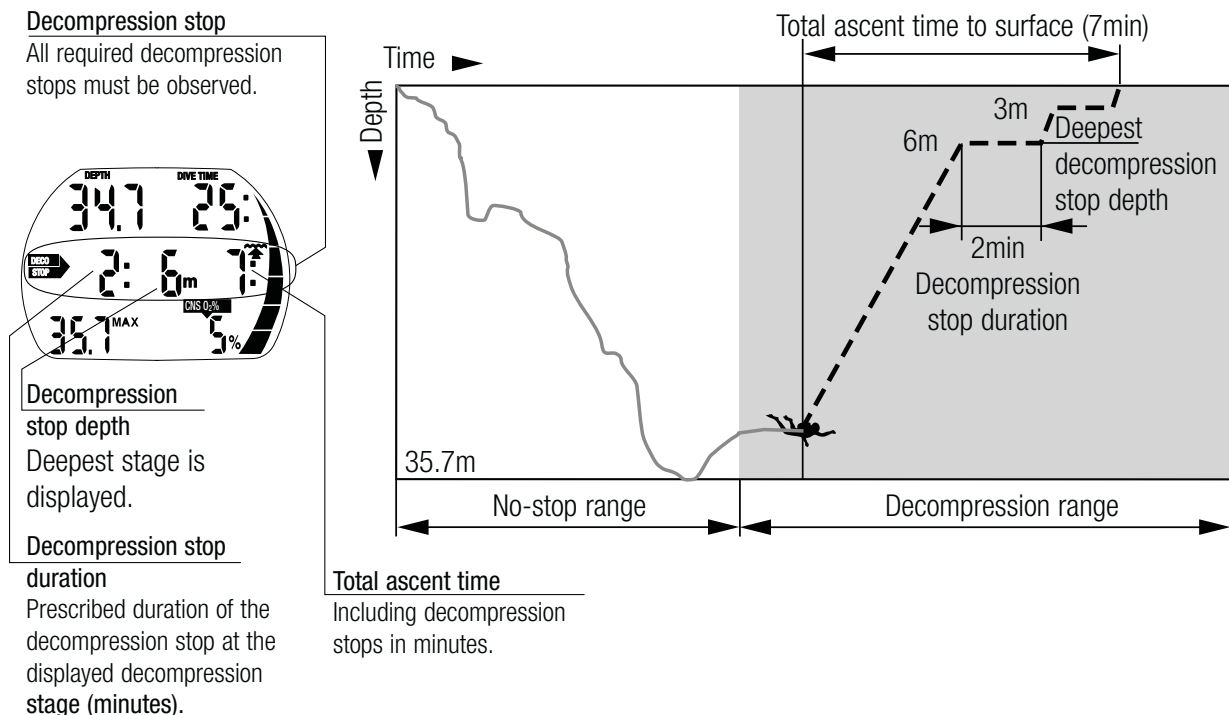

1.3 Nitrox information (O₂ information)

For dives with compressed air in normal recreational diving, nitrogen is the decisive gas for the decompression calculations. When diving with Nitrox, the risk of oxygen toxicity rises with the increase of the fraction of oxygen and the increase of depth and can limit dive time and the maximum depth. ONE includes this in the calculations and displays the necessary information:

O₂% mix Fraction of oxygen: The fraction of oxygen in the Nitrox mixture can be set between 21% (normal compressed air) and 50% in 1% increments. Your selected mix will be the basis for all calculations.

ppO₂ max Maximum allowed partial pressure of oxygen: the higher the fraction of oxygen in the mixture, the shallower the dive depth at which this value of the partial pressure of oxygen is reached. The depth at which ppO₂ max is reached is called Maximum Operating Depth (MOD).

When you enter the settings for the gas mixture, ONE will display the ppO₂ max limit setting and the corresponding MOD. ONE warns you audibly and visually once the depth is reached at which the ppO₂ reaches the maximum allowed value ->23.



- Default setting of ppO₂ max is 1.4bar.
The value of ppO₂ max can be set by means of LogTRAK or with "set 1" between 1.2 and 1.6bar (->32). It can also be changed at the time of setting the gas mixture (->23).
- The CNS O₂% value/alarm is not influenced by the selected ppO₂ max setting.

CNS O₂% Oxygen toxicity: With the increased percentage of oxygen, the oxygen in the tissues, especially in the central nervous system (CNS), becomes important. If the partial pressure of oxygen rises above 0.5bar, the CNS O₂ value increases, if the partial pressure of oxygen is below 0.5bar, the CNS O₂ value decreases. The closer the CNS O₂ value is to 100%, the closer the limit where symptoms of oxygen toxicity can occur.

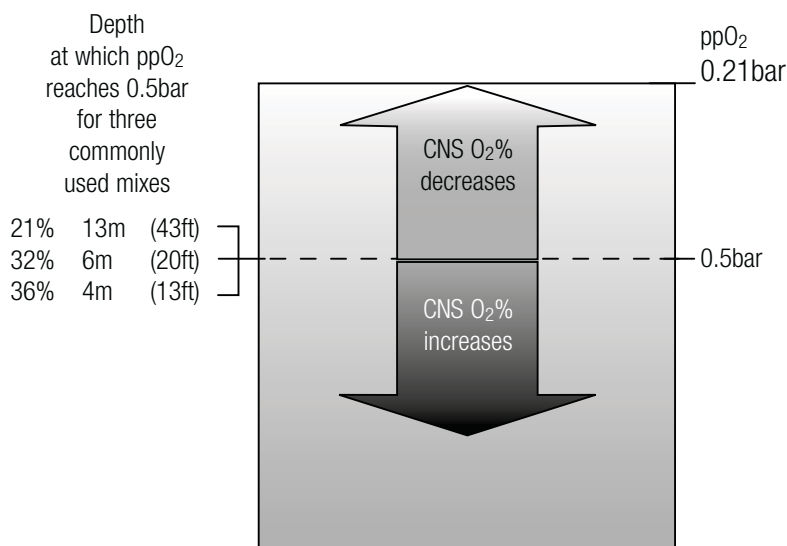

WARNING

Nitrox diving may only be attempted by experienced divers after proper training from an internationally recognized agency.

2 Attention messages and alarms

ONE draws the diver's attention to certain situations and warns the diver of unsafe diving practices. Attention messages and alarms are visual and / or audible.



- The audible attention messages can be switched off in "set 1" ->33 or LogTRAK. With LogTRAK they can be switched off selectively.
- In addition, the sound can be turned off completely in "set 2" ->35.



WARNING

If you turn off the sound you will have no audible warnings. Without audible warnings you could inadvertently get into potentially hazardous situations which could result in death or serious injury.



WARNING

Serious injury or death may result from failing to immediately respond to alarms given by ONE.

2.1 Attention messages

Attention messages are communicated to the diver visually by symbols, letters or flashing figures. In addition, two short audible sequences can be heard (in an interval of 4 seconds) in two different frequencies under water.

•••• 4s •••• (can be switched off)

Attention messages come up in the following situations (more information can be found on the listed pages):

- | | |
|---|---------|
| • Maximum Operating Depth / ppO ₂ max is reached | Page 23 |
| • Oxygen toxicity reaches 75% | 23 |
| • No-stop time less than 3 minutes | 24 |
| • Prohibited altitude (surface mode) | 28 |
| • Entering decompression | 25 |

2.2 Alarms

Alarms are given to the diver visually by flashing symbols, letters or figures. In addition, an audible sequence in one frequency can be heard during the whole duration of the alarm.

•••••••• •••••••• ••••••••

An alarm occurs in the following situations (more information can be found on the listed pages):

- | | |
|--|---------|
| • Oxygen toxicity reaches 100% | Page 23 |
| • Ignored decompression | 25 |
| • Exceeding the prescribed ascent rate (Particular scale of beeps, ->22) | 22 |
| • Low battery alarm (without audible alarm): the battery icon appears if the battery has to be replaced. | 15 |

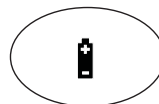

3 Preparation for the dive

You have to check the settings of ONE especially before the first dive. All settings can be checked and changed directly at ONE or via LogTRAK.

3.1 Setting the gas mixture and ppO₂ max [0.6]

! WARNING

Before every dive and after changing the tank, make sure that the settings for the gas mixture correspond with the current mixture used. An incorrect setting causes ONE to miscalculate this particular dive. If the fraction of oxygen is set too low this can lead to oxygen poisoning without warning. If the value is set too high decompression sickness may occur. Inaccuracies in the calculations are carried over to repetitive dives.

or until [0.6]

To set the gas mixture, ONE must be in user mode (time of day display).

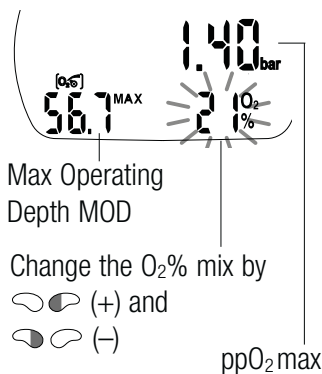

1. Push or until the symbol for the setting of the O₂ mixture appears.
2. Confirm that you wish to change the displayed oxygen fraction by pushing .
3. Change the oxygen fraction in increments of 1% by pushing or . ONE will display the current fraction of oxygen, the maximum partial pressure limit (ppO₂ max) and the MOD.
4. Confirm the selected percentage with .

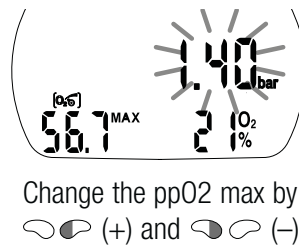

5. By pushing or you can change the ppO₂ max for the chosen fraction of oxygen down to 1.0bar. ONE will now display the corresponding MOD for the new ppO₂ max.
6. Confirm your ppO₂ max settings with .



- Without confirmation the display will disappear after 3 minutes and your entries will not be accepted.
- Automatic reset of the O₂% mix to 21% can be set with "set 1" ->32 or LogTRAK between 1 and 48 hours or to "no reset" (default).

3.2 Preparation for the dive and function check

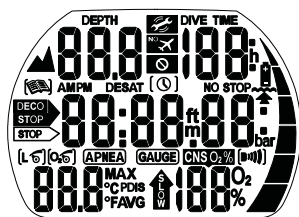

Switch on ONE by pushing and check the test display: Are all elements of the display activated? Do not use ONE if the display does not show all elements. When switching on ONE with , the test display will not appear.

! WARNING

Check the battery capacity before each dive ->14.

4 Functions during the dive

4.1 Immersion

If the water contacts are deactivated (->33), switch on ONE before immersion.

! WARNING

If you have chosen the option "Water contacts off" ("set 1" or LogTRAK), ONE will turn on with a delay of up to 1 minute into the dive. This will affect functioning of the computer. Make sure that the computer is on before starting the dive.

After immersion, starting at a depth of about 0.8m (3ft), all diving functions are monitored, i.e. depth and dive time displayed, maximum depth stored, saturation of tissues calculated, no-stop time or decompression prognosis determined, ascent rate controlled and displayed and the correctness of the decompression procedure supervised.

4.2 Dive time

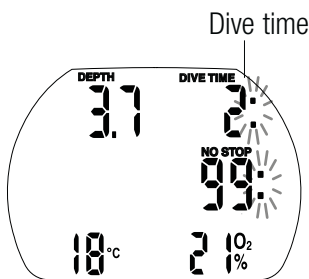

The whole time spent below a depth of 0.8m (3ft) is displayed as dive time in minutes. The time above 0.8m (3ft) is counted as dive time only if the diver descends again below 0.8m (3ft) within 5 minutes.

While the dive time is running, the colons on the right of the figures are flashing in one second intervals. Maximum dive time displayed is 199 minutes.



If a dive lasts longer than 199 minutes the dive time display starts again at 0 minutes.

4.3 Current depth / O₂% mix

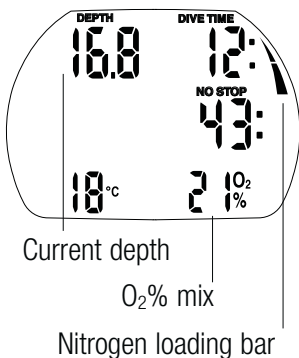

Current depth is given in 10cm increments in metric setting and 1ft increments in imperial setting. At a diving depth of less than 0.8m (3ft) the display shows " - - - ".

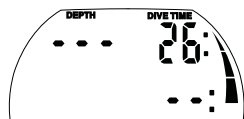

The O₂% mix is displayed as long as CNS O₂% = 0 and no ascent speed is indicated.



Depth measurement is based on salt water. Therefore, ONE shows a slightly (3%) shallower depth than actual when diving in fresh water. No calculation however is affected.

4.4 Maximum depth / Temperature

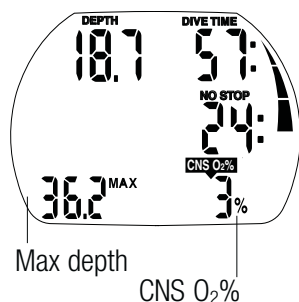

Maximum depth is only displayed if it exceeds the current depth by more than 1m (3ft) (maximum indicator function). If maximum depth is not displayed, ONE shows the temperature.

- > Temperature, O₂ mix
- > Temperature, Time, O₂ mix
- > Max depth

4.5 Ascent rate

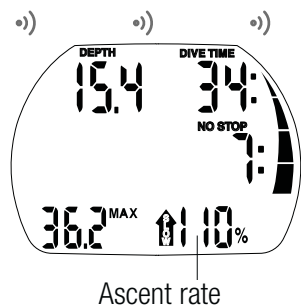

Optimal ascent rate varies depending on depth between 7 and 20m/min (23 and 67ft/min). It is displayed as a percent of the reference variable ascent rate. If the ascent rate is greater than 100% of the set value, the black arrow "SLOW" appears. If the ascent rate exceeds 140%, the arrow starts flashing. ONE provides an audible alarm if the ascent rate is 110% or greater. The intensity of the alarm increases in direct proportion to the degree that the prescribed ascent rate is exceeded.

! WARNING

The prescribed ascent rate must be observed at all times! Exceeding the prescribed ascent rate can lead to microbubbles in the arterial circulation which can lead to serious injury or death due to decompression sickness.

- In case of an improper ascent ONE may require a decompression stop even within the no-stop phase because of the danger of microbubble formation.
- The decompression duration necessary for the prevention of microbubbles can increase massively if the ascent rate is exceeded.
- From great depth a slow ascent may cause heightened saturation of tissues and an extension of both decompression duration and total ascent time.
At shallow depth, a slow ascent may shorten the decompression duration.
- Display of the ascent rate has the priority over "CNS O₂".

! WARNING

Ascent rate	Visual alarm	Audible alarm			
110%))))
140%))))))))
160%))))))))))))))))))))
180%))))))))))))))))))))

Reduce ascent rate

Excessive ascent rates for longer periods are entered in the logbook.

The following ascent rates correspond to the 100% value in ONE.

depth (m)	<6	<12	<18	<23	<27	<31	<35	<39	<44	<50	>50
speed (m/min)	7	8	9	10	11	13	15	17	18	19	20
depth (ft)	<20	<40	<60	<75	<88	<101	<115	<128	<144	<164	>164
speed (ft/min)	23	26	29	33	36	43	49	56	59	62	66

4.6 Partial pressure of oxygen (ppO₂ max) / Maximum Operating Depth (MOD)

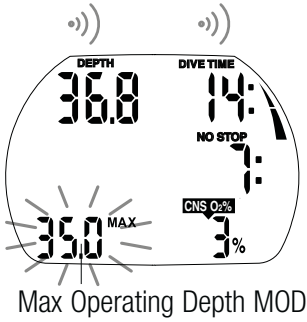

The maximum partial pressure of oxygen ppO₂ max (default 1.4bar) determines the Maximum Operating Depth (MOD). Diving deeper than the MOD will expose the diver to oxygen partial pressures higher than the set maximum level.

The ppO₂ max and consequently the MOD can be reduced manually (->20, setting the gas mixture, point 5).

In addition the maximum allowed ppO₂ can be set by means of LogTRAK or with "set 1" between 1.2 to 1.6bar ->32.

! WARNING

The MOD is a function of ppO₂ max and the mixture used. If during the dive the MOD is reached or exceeded ONE sends an audible attention message and the MOD is displayed (flashing) in the lower left corner.

Ascend to a depth shallower than the displayed MOD in order to diminish the danger of oxygen poisoning.

! WARNING

The MOD should not be exceeded. Disregarding the warning can lead to oxygen poisoning.

4.7 Oxygen toxicity (CNS O₂%)

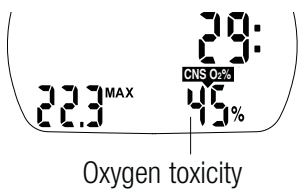

ONE calculates oxygen toxicity based on depth, time and the gas mixture and displays it in the location of the ascent rate. The toxicity is expressed in 1% increments of a maximum tolerated value (O₂ clock).

The symbol "CNS O₂" is displayed together with the percentage.

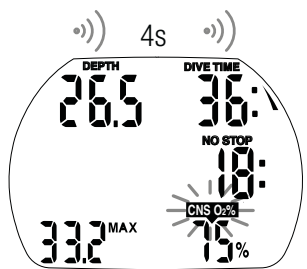

! WARNING

The MOD should not be exceeded. Disregarding the warning can lead to oxygen poisoning.

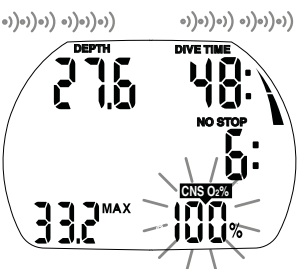

! WARNING

When oxygen toxicity reaches 100%, an audible alarm goes off every 4 seconds. "CNS O₂" and the percentage value flash. Danger of oxygen toxicity!

Start procedure for terminating the dive.



- During an ascent and if the CNS O₂% value does not increase anymore (due to a lower partial pressure of oxygen), the audible warning is suppressed.
- During the ascent, the display of the oxygen toxicity is replaced by the ascent rate. If the ascent is stopped, the display changes back to the indication of the CNS value.
- ONE will display CNS O₂% values exceeding 199 % with 199 %.

4.8 Nitrogen loading bar graph

The nitrogen loading bar gives a graphical representation of how close to decompression you are. As you absorb nitrogen during the dive, more and more segments of the bar will light up. Depending on your depth, the segments can light up more or less rapidly.



1-3 segments (green area): you are safely within the no-stop range.



4-5 segments (yellow area): you are approaching decompression. When the no-stop time drops below 3 minutes the 5 segments will start flashing.*



6 segments (red area): you now have mandatory decompression obligation(s) which you must observe before reaching the surface.

* Depending on your profile, the no-stop time may drop below 3 minutes before the upper 5 segments are lit. In this case, only those segments that are lit will flash.

If you have entered decompression, the 6th segment will turn off as soon as you complete your last decompression obligation to indicate that you are no longer in decompression.

4.9 Decompression information

NO STOP and the no-stop time (minutes) are displayed if no decompression stops are necessary.

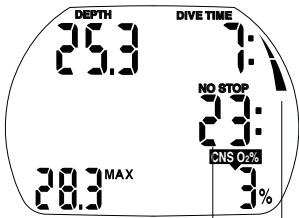

No-stop time
Nitrogen loading bar



- No-stop display "99:" means remaining time of 99 minutes or more.
- No-stop time is influenced by the water temperature.



No-stop time less than 1 minute

! WARNING

If no-stop time drops below 3 minutes, an audible attention signal is activated, the no-stop value and the nitrogen loading bar begin to flash. If no-stop time is less than 1 minute, the no-stop display shows the flashing value "0".

In order to prevent a decompression dive, ascend slowly until the no-stop time is 5 minutes or more.

! WARNING

Dives that require decompression stops are not recommended.

Decompression values

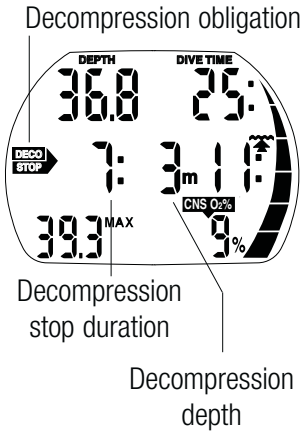

On entering the decompression phase, "NO STOP" disappears, the symbol appears and an attention beep goes off. The nitrogen loading bar stops flashing and the 6th segment lights up (red area). The deepest decompression stage in metres (feet) is displayed and the decompression stop duration of the displayed stage appears in minutes. The display "7: 3m (10ft)" means that a decompression stop of 7 minutes at a depth of 3m (10ft) has to be made.

When a decompression stop has been completed, the next (shallower) decompression stop is displayed. When all decompression stops have been completed, the symbol extinguishes, "NO STOP" and no-stop time reappear.

Deco stop depths deeper than 27m (90ft) are displayed as " -- : -- ".

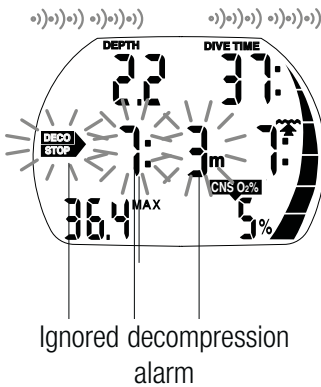

WARNING

The decompression alarm is activated if the decompression stop is ignored. The arrow , the decompression stop duration and decompression stop depth begin to flash and an audible alarm goes off. Due to the formation of microbubbles, decompression can increase massively if a decompression stop is ignored. When the surface is reached during the decompression alarm, the arrow , the decompression stop duration and decompression stop depth continue flashing, in order to point to the risk of a decompression accident. The SOS mode is activated 3 minutes after the dive if corrective action is not taken (->16).
If the total (cumulative) duration of the decompression alarm is longer than one minute, it is entered in the logbook.
Descend to the prescribed decompression stop depth immediately!

Total time of ascent

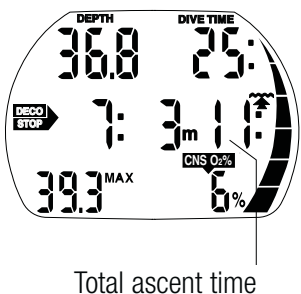

As soon as decompression stops are necessary ONE shows the total time of ascent. This includes the ascent time from the current depth to the surface and all decompression stop obligations.



The total time of ascent is calculated on the basis of the prescribed ascent rate. Total time of ascent can be subject to change if the ascent rate is not ideal (100%).

Ascent time greater than 99 minutes is displayed as " -- ".

WARNING

On all dives with ONE, make a safety stop for at least three minutes at a depth of 5m (15ft).

4.10 Safety stop timer

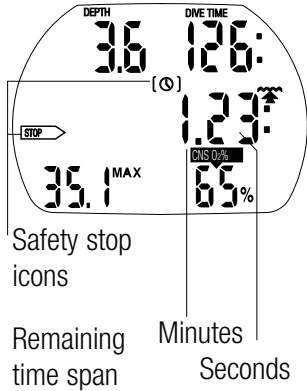

The safety stop timer displays the time span a diver should spend at the safety stop depth at the end of the dive. The timer is activated by the diver and counts back from 3 minutes to zero. It can be restarted any number of times.

The safety stop timer can be activated under the following conditions: depth <6.5m (21ft), no-stop display 99 minutes.

Activate the safety stop timer by pressing . The timer begins to count backwards and a bookmark will be created in the dive profile. If you press again, the timer will start again from the full value.

The safety stop timer will switch off automatically if the depth exceeds 6.5m (21ft) or the no-stop phase is shorter than 99 minutes.

5 Functions at the surface

5.1 End of a dive

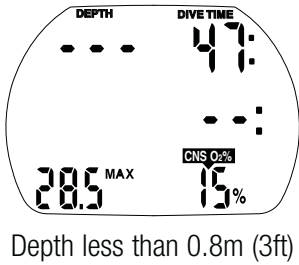

After reaching the surface (<0.8m/3ft) ONE remains in dive mode for 5 minutes. The delay allows for surfacing for a short period for orientation. After 5 minutes the dive is closed and it is entered into the logbook. The time of day is then displayed for 3 minutes, after which the computer turns off.

WARNING

For the calculations of the desaturation and no-fly time it is assumed that the diver breathes air while on the surface.

5.2 Residual nitrogen bar graph

The segments in the residual nitrogen bar graph will gradually turn off as ONE follows the offgassing of your tissues during your surface interval. There is a 1:1 equivalence in the meaning of the segments between diving and surface. Thus, on a repetitive dive the bar will resume from its status on the surface just prior to the dive. There are two exceptions however:

- the uppermost segment will stay lit until the desaturation time is completely extinguished. This is done to show that there is desaturation time left and that a dive started at this point will be logged as a repetitive dive. If the remaining desaturation time is very short, this segment could however at first disappear during the dive;
- during the 24 hours of an SOS-lock, all segments will stay on.

5.3 Desaturation time, No-fly time and No-dive warning

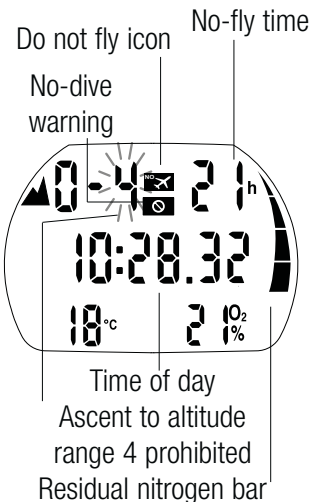

5 minutes after a dive ONE shows the time of day, the "do not fly time", the no-dive warning (if applicable), the current altitude range and the prohibited altitude range (->27).

No-fly time is the time in hours that should pass before a flight and is displayed and adjusted until the value becomes 0 hours.

WARNING

Flying while ONE displays "do not fly" may lead to serious injury or death from decompression sickness.

! WARNING

If the "no-dive" warning is visible during the surface interval, the diver should not undertake another dive.

To check the remaining desaturation time and oxygen toxicity press .

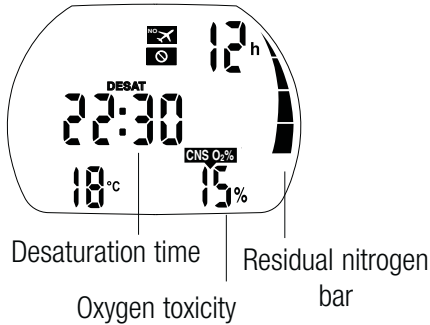

Desaturation time is determined either by oxygen toxicity, nitrogen saturation or the regression of microbubbles, depending on which requires the longer time.

To check the elapsed surface interval press .

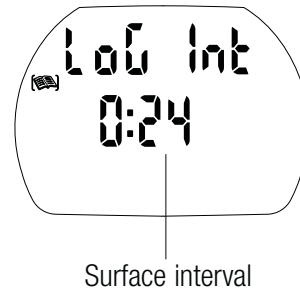

No-dive warning

If ONE detects a situation of increased risk (due to the potential of microbubble accumulation from previous dives or a CNS O₂ level above 40%), the no-dive symbol will appear on the display. The duration of the no-dive warning is visible in the dive planner menu. ONE recommends this as minimum surface interval in order to reduce the number of microbubbles and/or to reduce the CNS O₂ level below 40%.



You should not undertake a dive as long as the no-dive warning message is displayed on the computer screen. If the warning is prompted by microbubble accumulation (as opposed to CNS O₂ over 40%) and you dive anyway, you will have shorter no-stop times or longer decompression times. Moreover, the duration of the no-dive warning at the end of the dive can increase considerably.

6 Diving in mountain lakes

6.1 Altitude ranges

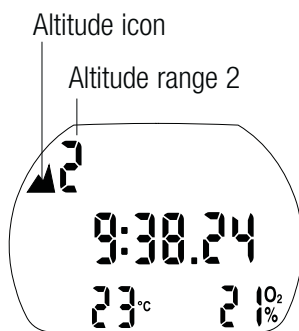

ONE measures the atmospheric pressure every 60 seconds even while the display is switched off. If the computer detects a sufficient increase in altitude, it switches on automatically and indicates the new altitude range (1-4) and the desaturation time. Desaturation time indicated at this moment refers to adaptation time at this altitude. If the dive starts within this adaptation time, ONE treats it as a repetitive dive, since the body is offgassing. Altitude is divided into five ranges, which are influenced by barometric pressure. That is why the defined altitude ranges overlap on their fringes. If a mountain lake is reached, the altitude range is indicated at the surface (time of day display), in the logbook and in the dive planner by a stylised mountain

and the current altitude range. Sea level to an altitude of approximately 1000m (3300ft) is not indicated. In the following diagram, you can see the approximate breakdown of the altitude ranges:

0 1 2 3 4
Altitude ranges

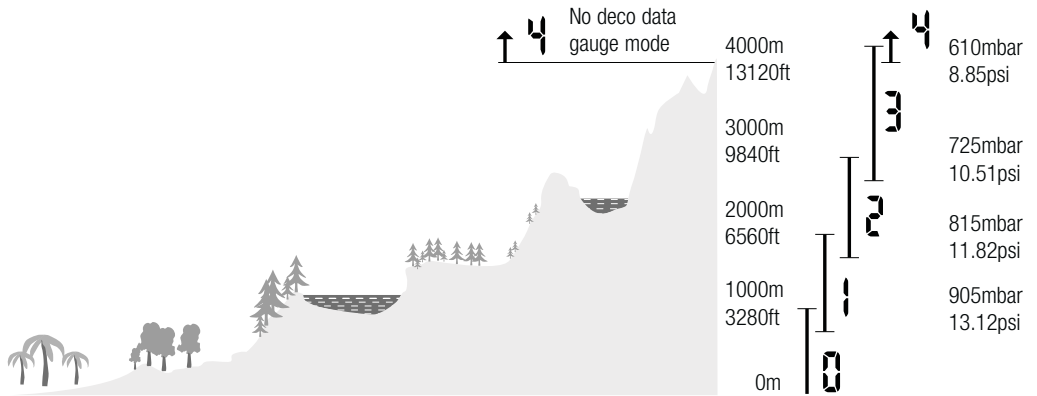

6.2 Prohibited altitude

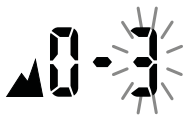

Ascent to altitude range 3 and 4 prohibited.
Max allowed altitude: 2650 m (8694ft).

WARNING
 Flying while ONE displays "do not fly" may lead to serious injury or death from decompression sickness.

Max altitude:	850m 2790ft	1650m 5413ft	2650m 8694ft	4000m 13120ft



The ascent prohibition can also be displayed together with an altitude range: Example: You are at 1200m (3937ft) (altitude range 1) and you may ascend to range 2 only (2650m / 8694ft). You may not rise to the altitude range 3 or 4.

6.3 Decompression dives in mountain lakes

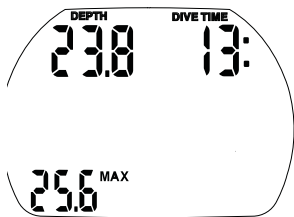

Dive at altitude range 4:
 • no deco data (autom. gauge mode)

In order to assure optimal decompression even at higher altitudes, the 3m (10ft) decompression stage is divided into a 4m (13ft) stage and a 2m (7ft) stage in altitude ranges 1, 2 and 3. The prescribed decompression stop depths are, in sequence, 2m / 4m / 6m / 9m... (7ft / 13ft / 20ft / 30ft...).

If atmospheric pressure is below 620mbar (8.99psi) (altitude higher than 4100m / 13450ft above sea level), no decompression data is calculated and displayed (automatic gauge mode). In addition, the dive planner is not available anymore.

IV Dive planner

PLn: ONE has a dive planner which allows the planning of no-stop dives.

Basis of the planning:

- selected fraction of oxygen and MOD
- water temperature of the most recent dive
- altitude range (if any)
- status of saturation at the time the dive planner is selected
- assuming a normal workload of the diver and observance of the prescribed ascent rates

1 Planning a no-stop dive

To select the dive planner ONE must be in user mode (**time of day display**). Push or until the symbol for the dive planner PLn appears.

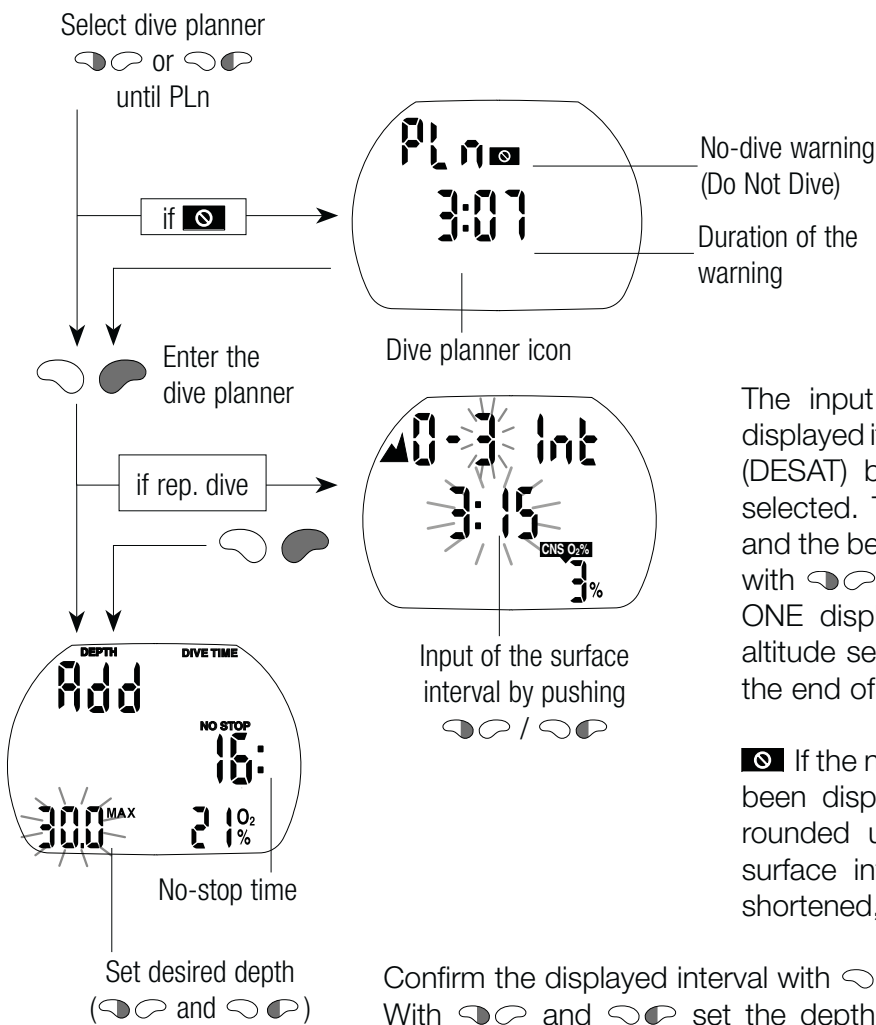

The no-dive warning and its duration are displayed if ONE detects an increased risk due to the accumulation of microbubbles.

Enter the dive planner with .

The input window for the time interval is displayed if there was a remaining desaturation (DESAT) before the dive planner has been selected. This surface interval between now and the beginning of the dive can be changed with and in steps of 15 minutes. ONE displays the CNS O₂% value and the altitude section to which you may not rise at the end of the selected surface interval.

If the no-dive warning and its duration has been displayed, ONE proposes this time – rounded up to the next 15 minutes – as surface interval. If the proposed interval is shortened, the no-dive warning appears.

Depths deeper than the MOD for the selected gas (O₂ mix) are not displayed.

On page 27 you will find further information and safety considerations regarding the no-dive warning.

2 Leaving the dive planner

By pushing once or twice you can exit the dive planner. This also occurs after three minutes without operation.

V Logbook

1 Survey

A dive is entered in the logbook if the dive time is longer than 2 minutes. ONE records the profiles of about 25 hours of diving. This information can be transferred to a PC with the standard infrared interface (IrDA) and the Windows® software LogTRAK. All dives in the memory can be displayed directly on the dive computer.

2 Operation

From the **time of day** display you can select the logbook (📖) with ⏪.

⏪ until (📖)

From the time of day display you can select the logbook (📖) with ⏪.

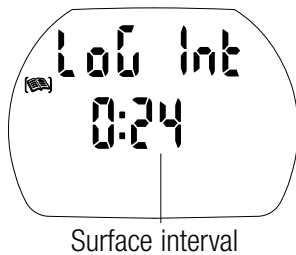

Surface interval

If there was a remaining desaturation time (DESAT) before selecting the logbook, the time since the last dive (surface interval) is displayed.



Page 1

With ⏪ you enter the logbook.

The most recent dive is displayed (dive number 1).

There are 3 pages for each dive.

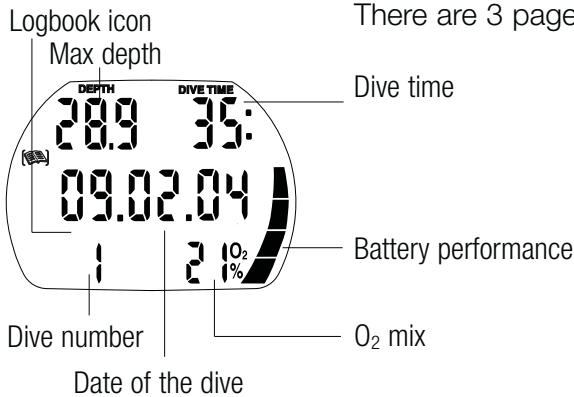

Dive time

Battery performance

O₂ mix

From here you can:

a) get more information about the displayed dive by pushing

b) select other dives. Each time you push ⏪ or ⏩ causes a jump to the next or previous dive. At the end of the logbook ONE displays statistic information ->31.



ONE displays further information about the selected dive.

Page 2

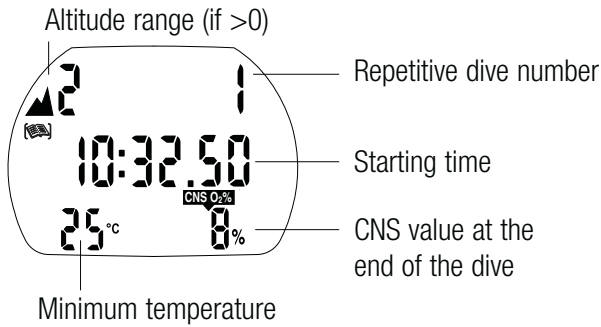

Push to get more information about the dive.

Page 3

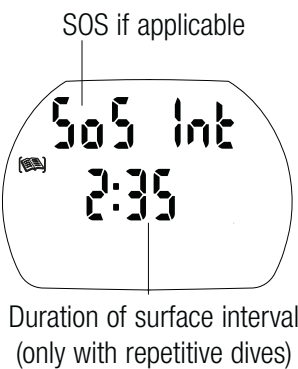

If a dive is started within adaptation time (after a change of altitude), the adaptation time is displayed instead of the surface interval.

Further possible information about the dive:



Too fast ascent* (page 1)



Ignored decompression stop* (page 1)



Ignored decompression stop* (page 3)



Altitude range (page 2)



DESAT Desaturation was reset before the dive by removing the battery (page 1, 2)



Battery quality factor has been 3 bars or less during the dive (page 1, 2, 3)



No-dive warning after the dive (page 1)

*Alarms during the dive

gets you back to the dive list (first level screen within logbook). From here you can advance to the next dive of interest and press to retrieve more information about that dive etc.

Statistic information

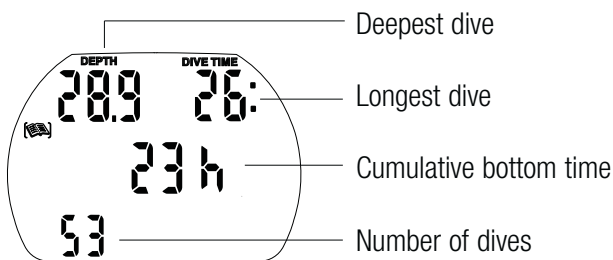

From the time of day display you can get the following statistic information over all dives. Push , and .

Leaving the logbook

By pushing once or twice you can exit the logbook. The logbook closes automatically after 3 minutes without operation.

VI Settings

1 Menu "set 1"

With menu "set 1" or LogTRAK you can configure the following items (dive functions):

Setting	Range	Default	Page
• Maximum partial pressure of oxygen (ppO ₂ max)	1.2-1.6bar	1.4bar	32
• Time limit to reset the O ₂ % mix to air	no reset / 1 - 48hrs	no reset	32
• Unit system	metric/imperial		32
• Audible attention signals	on / off (LogTRAK: selective)	on	33
• Water contacts	on / off	on	33
• Reset desaturation	on / off	no reset	33

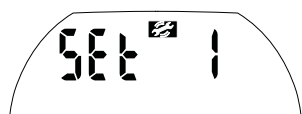

Starting from the time of day display push or until "set 1" appears.

Confirm that you wish to enter into the menu of "set 1" by pushing . Once entered into the menu you can scroll with and through the menu.

Setting the maximum partial pressure of oxygen (ppO₂ max)



1. Confirm that you wish to change the ppO₂ max by pushing . The current value starts to flash.
2. Change the value in increments of 0.05bar by pushing or .
3. Confirm the selected value with .

Setting the time limit to reset the O₂% mix to air

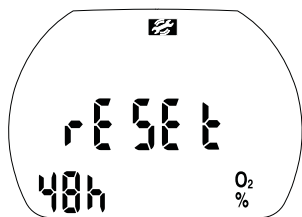

Time limit to reset O₂ mix to air

1. Confirm that you wish to change the time limit of the reset by pushing . The current setting starts to flash.
2. Change the time limit by pushing or (1 - 48hrs or no reset: "-- h")
3. Confirm the selected value with .

Selecting the units

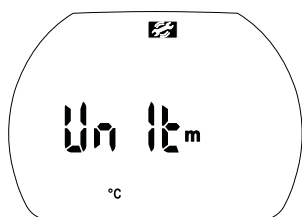

1. Confirm that you wish to change the units by pushing . The selected units are displayed (m / ft / °C / °F).
2. Push . "m" or "ft" starts to flash.
3. Switch with between "m" and "ft".
4. Confirm the selected unit with . "°C" or "°F" starts to flash.
5. Switch with between "°C" and "°F".
6. Confirm the selected unit with .

Switching the audible attention signals on and off

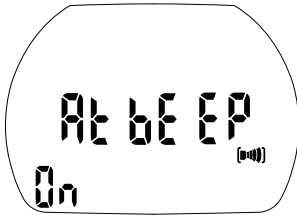

With this option you can switch off the audible attention signals only (the audible alarms remain active). Refer to page 19 to see this distinction.

1. Confirm that you wish to change the setting of the audible attention signals by pushing . "On" or "off" starts to flash.
2. Switch between "on" or "off" by pressing .
3. Confirm the setting with .

Switching the water contacts on and off

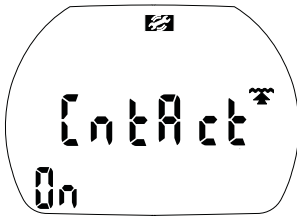

On submerging in water the water contacts switch on ONE automatically.

WARNING

If you chose the option "Water contacts off", ONE will turn on with a delay of up to 1 minute into the dive. This will affect functioning of the computer.

Make sure that the computer is on before starting the dive.

1. Confirm that you wish to change the setting of the water contacts by pushing . "On" or "off" starts to flash.
2. Switch between "on" or "off" by pressing .
3. Confirm the setting with .

Resetting the remaining saturation

WARNING

Diving after a reset of the remaining saturation may lead you into potentially hazardous situations which could result in death or serious injury. After a reset of the remaining saturation do not dive for at least 48 hours. If you dive after resetting the remaining saturation the computer will miscalculate your decompression, which may result in serious injury or death.

Reset the remaining saturation only if you know you will not be diving, flying or going to higher altitude for the next 48 hours.

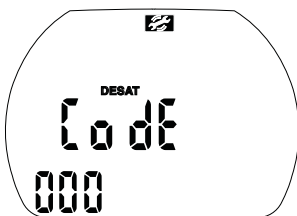

Resetting the desaturation should only be done when there is a valid reason, e.g. loaning the computer to somebody who has not dived in 48 hours or more. When the computer itself has remaining saturation you must assume full responsibility for the consequences of resetting the remaining saturation.

1. Confirm that you wish to reset the displayed saturation by pushing . "On" starts to flash.
2. Switch between "on" or "off" by pressing .
3. Confirm the setting with . If you have selected "off", "Code" and "000" appear.
4. Set the first digit by pushing and . Confirm with . Repeat point 4 for the next 2 digits. If you entered the right code the desaturation will be reset to zero (desat off).

Code: 313

2 Menu "set 2"

With menu "set 2" or LogTRAK you can configure the following items:

Setting	Range	Default	Page
• Alarm clock	0 - 23h 59min, on/off	12:00, off	34
• UTC zone	±13hrs, increments: 15min		34
• Time of day	hours:minutes		34
• 24 or AM/PM setting	24 (off) / AM/PM (on)		35
• Date			35
• Display contrast	1 (low) -12 (high)	4	35
• IrDA speed (set 2 only)	low / high	low	35
• Sound	on / off	on	35
• Show ONE electronic ID			36

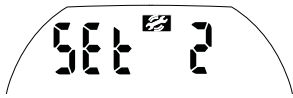

Starting from the time of day display push or until "set 2" appears.

Confirm that you wish to enter into the menu of "set 2" by pushing . Once entered into the menu you can scroll with and through the menu.

Setting the alarm clock time



The alarm clock goes off only at the surface. "Sound" must be turned "on" in "set 2".

1. Confirm that you wish to set the alarm time by pushing . The hours start to flash.
2. Set the hours by pushing or .
3. Confirm the setting with . The minutes start to flash.
4. Set the minutes by pushing or .
5. Confirm the setting with . "On" or "off" starts to flash.
6. "On" indicates "activated" (time of day display shows), "off" indicates "deactivated". Switch between "on" or "off" by pressing .
7. Confirm the selected status with .

Setting the UTC offset (coordinated universal time)

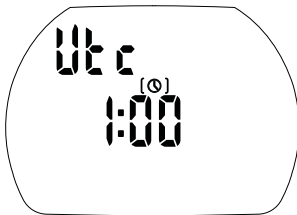

This setting allows you to quickly set the watch to a new time zone without affecting the actual time setting.

1. Confirm that you wish to set the UTC offset by pushing . The hours start to flash.
2. Set the hours by pushing or (±13hrs).
3. Confirm the setting with . The minutes start to flash.
4. Set the minutes in increments of 15 minutes by pushing or .
6. Confirm the selected status with .

Adjusting the time of day

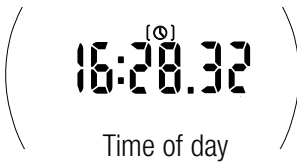

You can adjust it to your time zone either in this menu or using the UTC offset (see above).

1. Confirm that you wish to adjust the time of day by pushing . The hours start to flash.
2. Set the hours by pushing or .
3. Confirm the setting with . The minutes start to flash.
4. Set the minutes by pushing or .
5. Confirm the setting with .

Selecting 24 hours or AM/PM setting

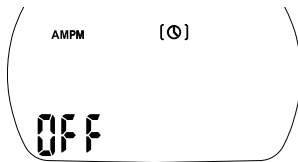

1. Confirm that you wish to change the setting by pushing . "On" or "off" starts to flash.
2. Switch with between "on" (AM/PM) and "off" (24h).
3. Confirm the setting with .

The 24h - AM/PM setting influences the display of the date (see below).

Adjusting the date

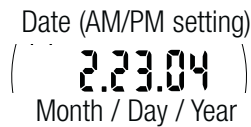
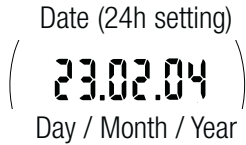

1. Confirm that you wish to adjust the date by pushing . The first day (month) starts to flash.
2. Set the day (month) by pushing or .
3. Confirm the setting with . The month (day) starts to flash.
4. Set the month (day) by pushing or .
5. Confirm the setting with . The year starts to flash.
6. Set the year by pushing or .
7. Confirm the setting with .

Adjusting the display contrast

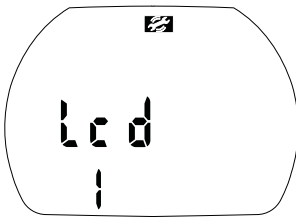

1. Confirm that you wish to adjust the display contrast by pushing . The current setting starts to flash.
2. Set the contrast by pushing or . Low contrast: (1), high contrast: (12)
3. Confirm the setting with .

Selecting the IrDA speed

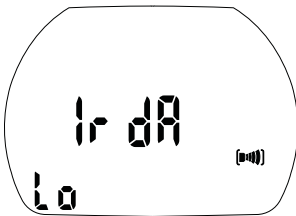

The default setting is low. For faster downloads you can set it to high, but not all IrDA interfaces are compatible with high.

1. Confirm that you wish to change the IrDA speed by pushing . "Lo" (low) or "hi" (high) starts to flash.
2. Switch with between low and high.
3. Confirm the setting with .

Low: 9600bits / second High: max 57 600bits / second

Switching the sound on and off

WARNING





If you turn off the sound, the buzzer is effectively deactivated. You will have no audible warnings (alarms and attention messages)! Without audible warning you could get into potentially hazardous situations, which could result in death or serious injury.

You must assume full responsibility for turning off the sound.



1. Confirm that you wish to change the setting by pushing . "On" or "off" starts to flash.
2. Switch with between "on" and "off".
3. Confirm the setting with . If you have selected "off", "Code" and "000" appear.



4. Set the first digit by pushing   and  . Confirm with  .
- Repeat point 4 for the next 2 digits. If you entered the right code the sound will be turned off.
Code: 313



Setting the "sound" to "off" applies also to surface functions (mountain alarm, wake-up alarm, change of altitude range).

Showing the hardware electronic ID of ONE

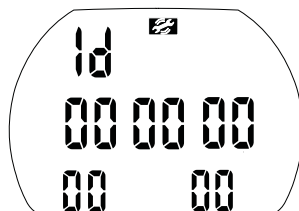

ID Number

This number is needed when reporting problems or for other maintenance related issues.

VII Appendix

1 Technical information

Operating altitude:	With decompression information: sea level up to approx. 4000m (13000ft); without decompression, above approx. 4000m (13000ft): automatic gauge mode (unlimited)
Max displayed depth:	120m (395ft), resolution between 0.8m and 99.9m: 0.1m, >99.9m: 1m. The resolution in feet is always 1 foot.
Decompression calculation depth range:	0.8 to 120m (3 to 395ft)
Maximum environment pressure:	13bar (189psi)
Clock:	Quartz clock, time, date, dive time display up to 199 minutes.
O₂ concentration:	Adjustable between 21%O ₂ (compressed air) and 50% O ₂
Operating temperature:	-10° to +50°C (14°F to 122°F)
Power supply:	CR2450, recommended brands: PANASONIC, DURACELL, RENATA, ENERGIZER, SONY, VARTA.
Life of the battery:	2-3 years or 200-300 dives. Actual life of the battery depends on the quantity of dives per year, the use of the backlight and the length of the dives. In cold water the life of the battery is reduced. Not all CR2450 batteries are the same, and low quality batteries can have very short life.

2 Maintenance

ONE is virtually maintenance free. All you need to do is to rinse it carefully with fresh water after each use and to have the batteries changed when needed ->37. To avoid possible problems with your ONE, the following recommendations will help assure that it will give you years of trouble free service:

! WARNING

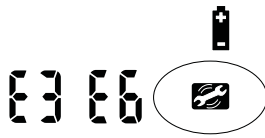

- Avoid dropping or jarring your ONE.
 - Do not allow your ONE to be exposed to direct, intense sunlight.
 - Rinse your ONE thoroughly with fresh water after each dive.
 - Do not store your ONE in a sealed container; make sure there is free ventilation.
 - If there are problems with the water contacts, use soapy water to clean ONE and dry it thoroughly. The surface of your ONE housing can be treated with silicone grease. Do not apply grease to the water contacts!
 - Do not clean ONE with liquids containing solvent (apart from water).
 - Check the battery capacity before each dive ->15.
 - If the battery icon appears, replace the battery ->37.
 - Diving with a weak battery: ONE may stop working during the dive, service icon and error code "E3" or "E6" appear. Close the dive and replace the battery ->37.
 - On the surface: if service icon and error code "E3" appear, replace the battery ->37.
- All error codes other than E3: ONE must not be used for any further dives. Take your dive computer to an authorized Scubapro dealer.

2.1 Replacing the battery (Battery kit includes battery and Teflon coated o-ring)

! WARNING

Removing the battery clears all physiological data including saturation. This means that for a repetitive dive the computer will not compute correctly. Diving after replacing the battery when there is desaturation time left on the computer can lead to serious injury or death from decompression sickness.

Change the battery only under these conditions:

- After a dive if you know you will not be diving, flying or going to higher altitude for the next 48 hours.
- Before a dive if there is no desaturation time left on the computer.

The change must be made with particular care in order to prevent water from seeping in. The warranty does not cover damages due to an improper replacement of the battery.

! WARNING

Never touch the metal surface of the battery with bare fingers.
The two battery poles must never be short circuited.

Procedure:

To replace the battery you need a coin or a universal tool and a clean cloth.

! WARNING

- A leaking battery cap may lead to the destruction of ONE by water seeping in or cause ONE to switch off without prior notice.
- Always open the battery compartment in a dry and clean environment.
- Only open the battery compartment to replace the battery.



1. Dry ONE with a soft towel.
2. Turn the battery cap with a coin or an universal tool.
3. Remove the battery cap.
4. Remove the o-ring carefully. Do not damage the sealing surfaces.
5. Remove the battery. Do not touch the contacts.



Protect the environment and dispose the battery properly.

! WARNING

If you notice traces of seeping water, damages, or other defects on the o-ring, do not use ONE for further dives. Take it to an authorized Scubapro dealer for check and repair.

6. Always insert a new o-ring when you replace the battery and dispose the old o-ring. Make sure that the new o-ring is in perfect condition, and that o-ring, o-ring groove and the sealing surfaces are free of dust and dirt.
If necessary, clean the parts with a soft cloth. Fit the o-ring in the o-ring groove of the battery cap.

! WARNING

7. Use only an original Scubapro o-ring. This o-ring is Teflon coated and does not require additional lubrication.
8. Do not lubricate the o-ring as the lubricant will chemically attack the battery cap.

! WARNING



9. Check the proper polarity of the battery. ONE can be damaged if you do not insert the battery correctly. Insert the new battery, with "+" pointing outwards, into the battery compartment.

After battery replacement ONE will perform an automatic test (8s) and gives a short beep when the test is done.

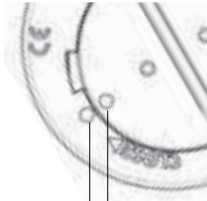
**WARNING**

Alignment circles

10. The battery cap can be installed with a $\pm 120^\circ$ offset. The alignment circles are there to ensure proper positioning of the cap. If the rotation is stopped before alignment, watertightness may not be ensured. If the rotation is forced beyond the alignment, the cap may break. Damage to ONE due to improper placement of the battery cap is not covered by warranty.

Push the battery cap firmly down and turn it clockwise until the two circles are aligned.

11. Check ONE by switching on   ->13 .

3 Warranty

The warranty only covers dive computers which have been bought from an authorized Scubapro retailer. The warranty is given for a period of two years.

Repairs or replacements during the warranty period do not increase the warranty period.

In order to put forward a warranty claim: send the dive computer together with a dated receipt of the purchase to your authorized retailer or an authorized servicing point.

Scubapro reserves the right to determine the merits of a warranty claim and to determine whether the computer will be repaired or replaced.

Excluded are faults or defects due to:

- excessive wear and tear;
- exterior influences, e.g. transport damage, damage due to bumping and hitting, influences of weather or other natural phenomena;
- servicing, repairs or the opening of the dive computer by anybody not authorized by the manufacturer;
- pressure tests which do not take place in water;
- diving accidents;
- improper placement of the battery cap.



Your dive instrument is manufactured with high-quality components that can be recycled and reused. Nevertheless these components, if not properly managed in accordance with the regulations on waste electrical and electronic equipment, are likely to cause harm to the environment and/or to human health.

Customers living in the European Union can contribute to protecting the environment and health by returning old products to an appropriate collection point in their neighborhood in accordance with EU Directive 2012/19/UE. Collection points are in particular provided by some distributors of the products and local authorities. Products marked with the recycling symbol on the left must not be disposed of in normal household waste.

4 Index

Active backlight _____	15	Surface interval _____	14, 29, 30
Alarm clock _____	16, 34	System _____	9
AM/PM _____	35	Technical information _____	36
Ascent rate _____	19, 22	Time of day (display) _____	13, 34
Audible attention signals _____	19, 33	Unit system _____	32
Backlight _____	15	UTC _____	34
Battery alarm _____	19	Warnings _____	19
Battery condition, Checking the... _____	15	Water calibration _____	21
Battery lifetime _____	36	Water contacts _____	10, 33
Battery replacement _____	37		
Beep, Switch off the... _____	33		
CNS O ₂ _____	17, 18, 19, 23		
Date _____	14, 35		
Deco data during decompression phase_	17, 25		
Deco data during no-stop phase _____	17, 24		
Decompression stop, Ignored... _____	19, 25		
Depth, current _____	21		
Display contrast _____	35		
Desaturation time _____	14, 26		
Desaturation, reset the... _____	33, 37		
Dive _____	17		
LogTRAK _____	10, 11, 30		
Dive planner _____	29		
Dive time _____	21		
Dive, end of a dive _____	26		
E3, E6 error code _____	37		
Electronic ID _____	36		
Fly, no-fly time _____	14, 26		
Gas mixture, Setting... _____	20		
IrDA _____	9, 35		
Light _____	15		
Logbook _____	30		
Maintenance _____	36		
Max depth _____	17, 23		
MOD _____	18, 19, 20, 23		
Mountain lakes, Diving in... _____	27		
Nitrogen loading bar graph _____	24		
Nitrox _____	18		
No-dive warning _____	26, 29		
No-stop time _____	17, 24		
O ₂ % mix, Set up... _____	20		
O ₂ fraction _____	17, 18, 20		
O ₂ partial pressure _____	18, 19, 23		
O ₂ partial pressure, ppO ₂ max ____	18, 20, 23, 32		
O ₂ toxicity _____	18, 19, 23		
Operating ONE _____	4, 5, 9		
PC, transfer to PC (logbook) _____	9, 11		
ppO ₂ , see O ₂ partial pressure			
Push buttons _____	4, 9		
Reset to air _____	32		
Residual Nitrogen bar graph _____	26		
Safety stop timer _____	26		
Set 1 _____	32		
Set 2 _____	34		
Setting the ppO ₂ max _____	20, 32		
Sound, on /off _____	19, 35		
SOS mode _____	16		