

SENA

30K

**MOTORCYCLE BLUETOOTH
COMMUNICATION SYSTEM
WITH MESH INTERCOM™**



**CLICK
ANY
SECTION
TO
BEGIN**

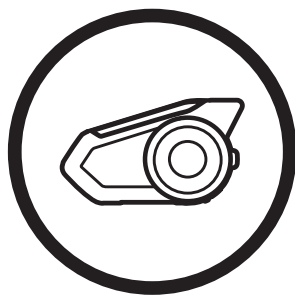

ABOUT THE
HEADSET

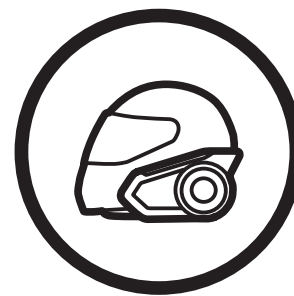

INSTALLING
THE HEADSET



GETTING
STARTED

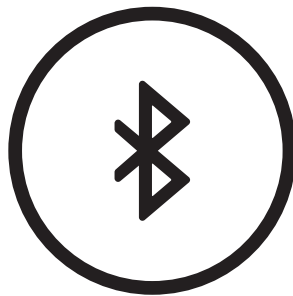

PAIRING WITH
DEVICES

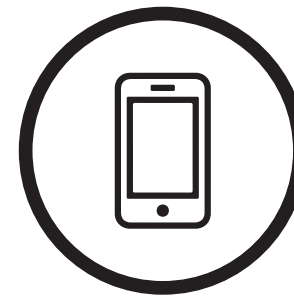

MOBILE
PHONE USAGE



STEREO
MUSIC

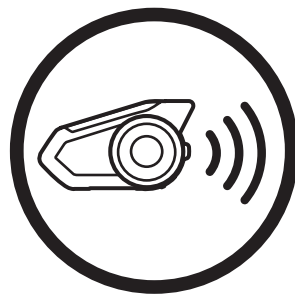

INTERCOM
SETUP

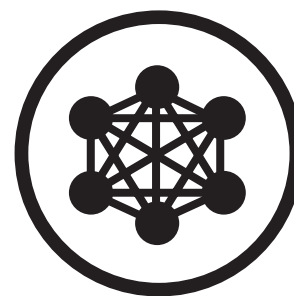

MESH
INTERCOM



AUDIO
MULTITASKING



USING THE
FM RADIO



AMBIENT MODE



VOICE
COMMAND

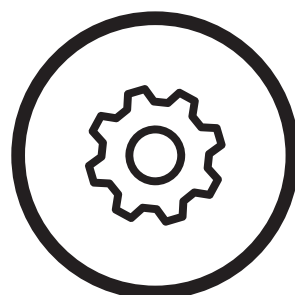

GENERAL
SETTINGS



REMOTE
CONTROL



TROUBLE-
SHOOTING

LEGEND:



Tap button/Jog Dial the specified number of times



Press and Hold button/Jog Dial for the specified amount of time

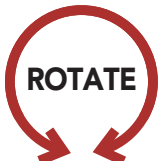

Rotate Jog Dial clockwise (right) or counterclockwise (left).

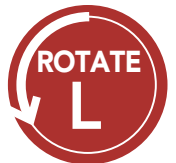

Rotate while Pressing Jog Dial clockwise (right) or counterclockwise (left).

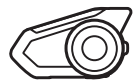

"Hello"

Audible prompt from the headset

TABLE OF CONTENTS

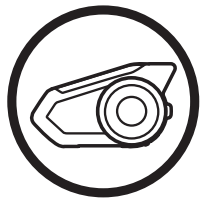

1. ABOUT THE MOTORCYCLE BLUETOOTH COMMUNICATION SYSTEM WITH MESH INTERCOM™ 9

- 1.1 Product Details 9**
 - 1.1.1 Headset Main Unit 9
 - 1.1.2 Universal Clamp Kit 9
- 1.2 Package Contents 10**

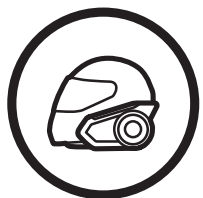

2. INSTALLING THE HEADSET ON YOUR HELMET 12

- 2.1 Helmet Installation 12**
- 2.2 Using the Glued Surface Mounting Adapter 15**
- 2.3 Switching the Microphone 17**
 - 2.3.1 Wired Boom Microphone 18
 - 2.3.2 Wired Microphone 18
- 2.4 Earbuds 19**
- 2.5 External Mesh Intercom Antenna 19**



3. GETTING STARTED 20

- 3.1 Button Functions 20**
- 3.2 Powering On and Off 21**
- 3.3 Charging 22**
- 3.4 Checking the Battery Level 23**
- 3.5 Volume Adjustment 25**
- 3.6 Downloadable Sena Software 26**
 - 3.6.1 Sena Device Manager 26
 - 3.6.2 Sena Smartphone App 26
- 3.7 Configuration Menu 28**

TABLE OF CONTENTS CONTINUED

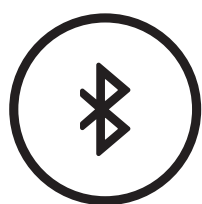

4. PAIRING THE HEADSET WITH OTHER BLUETOOTH DEVICES 32

- 4.1 Mobile Phone 32
- 4.2 Additional Mobile Phones, MP3 Player or Sena SR10 Two-Way Radio Adapter 33
- 4.3 Advanced Selective Pairing: Hands-Free or A2DP Stereo 34
 - 4.3.1 Phone Selective Pairing - Hands-Free Profile 34
 - 4.3.2 Media Selective Pairing - A2DP Profile 35
- 4.4 GPS Pairing 37



5. MOBILE PHONE USAGE 39

- 5.1 Making and Answering Calls 39
- 5.2 Speed Dialing 40
 - 5.2.1 Assigning Speed Dial Presets 40
 - 5.2.2 Using Speed Dial Presets 40
- 5.3 VOX Phone (Default: Enable) 42



6. STEREO MUSIC 43

- 6.1 Playing Music with Bluetooth Devices 43
- 6.2 Playing Music with non-Bluetooth Devices 44
- 6.3 Music Sharing 45
- 6.4 Audio Boost (Default: Disable) 47
- 6.5 Smart Volume Control (Default: Disable) 47

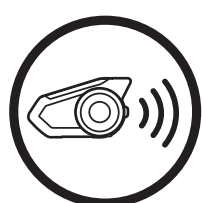

7. BLUETOOTH INTERCOM SETUP 48

- 7.1 Intercom Pairing 48
- 7.2 Two-Way Intercom 51

TABLE OF CONTENTS CONTINUED

7.3	Multi-Way Intercom	52
7.3.1	Starting a Three-Way Intercom Conference	52
7.3.2	Starting a Four-Way Intercom Conference	54
7.3.3	Ending Multi-Way Intercom	55
7.4	Three-Way Conference Phone Call with Intercom Users	55
7.5	Group Intercom	57
7.6	Universal Intercom	58
7.7	VOX Intercom (Default: Disable)	61
7.8	Intercom VOX Sensitivity (Default: 3)	62
7.9	HD Intercom (Default: Enable)	62
7.10	Advanced Noise Control™ (Default: Enable)	62

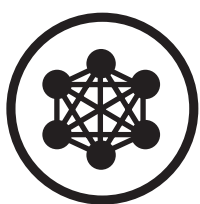

8. MESH INTERCOM **64**

8.1	What is Mesh Intercom?	63
8.2	Mesh Intercom Mode (Default: Public Mode)	64
8.2.1	Public Mode	64
8.2.2	Private Mode	65
8.2.3	Guest Mode (Default: Disable)	66
8.3	Using the Mesh	67
8.3.1	Creating the Mesh	67
8.3.2	Join an Existing Mesh	68
8.3.3	Quit the Mesh	69
8.3.4	Toggle Public Mode / Private Mode	70
8.3.5	Toggle Public Mode / Guest Mode	71
8.3.6	Mic Enable/Disable (Default: Enable)	71
8.4	Mesh Intercom Conference with Bluetooth Intercom Participant	72

TABLE OF CONTENTS CONTINUED



9. AUDIO MULTITASKING **74**

- 9.1 Audio Multitasking Settings 73
- 9.2 Intercom-Audio Overlay Sensitivity (Default: 3) 74
- 9.3 Audio Overlay Volume Management (Default: Disable) 74



10. USING THE FM RADIO **76**

- 10.1 FM Radio On/Off 75
- 10.2 Seek and Save Radio Stations 76
- 10.3 Scan and Save Radio Stations 78
- 10.4 Temporary Station Preset 79
- 10.5 Navigating Preset Stations 80
- 10.6 Region Selection (Default: Worldwide) 80
- 10.7 Radio Data System (RDS) Alternative Frequency (AF) Setting (Default: Disable) 81
- 10.8 FM Station Guide (Default: Enable) 81



11. AMBIENT MODE **82**



12. VOICE COMMAND **83**

- 12.1 Voice Command Setting (Default: Enable) 85

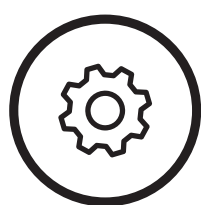

13. GENERAL SETTINGS **86**

- 13.1 Function Priority 86
- 13.2 Firmware Upgrades 86
- 13.3 Voice Prompts (Default: Enable) 87
- 13.4 Sidetone (Default: Disable) 87
- 13.5 Delete All Bluetooth Pairing Information 88

TABLE OF CONTENTS CONTINUED



14. REMOTE CONTROL

89

14.1 Pairing with the Remote Control

89



15. TROUBLESHOOTING

91

15.1 Fault Reset

91

15.2 Factory Reset

92



1. ABOUT THE MOTORCYCLE BLUETOOTH COMMUNICATION SYSTEM WITH MESH INTERCOM™

Product Details
Package Contents

1.1 Product Details

1.1.1 Headset Main Unit



1.1.2 Universal Clamp Kit

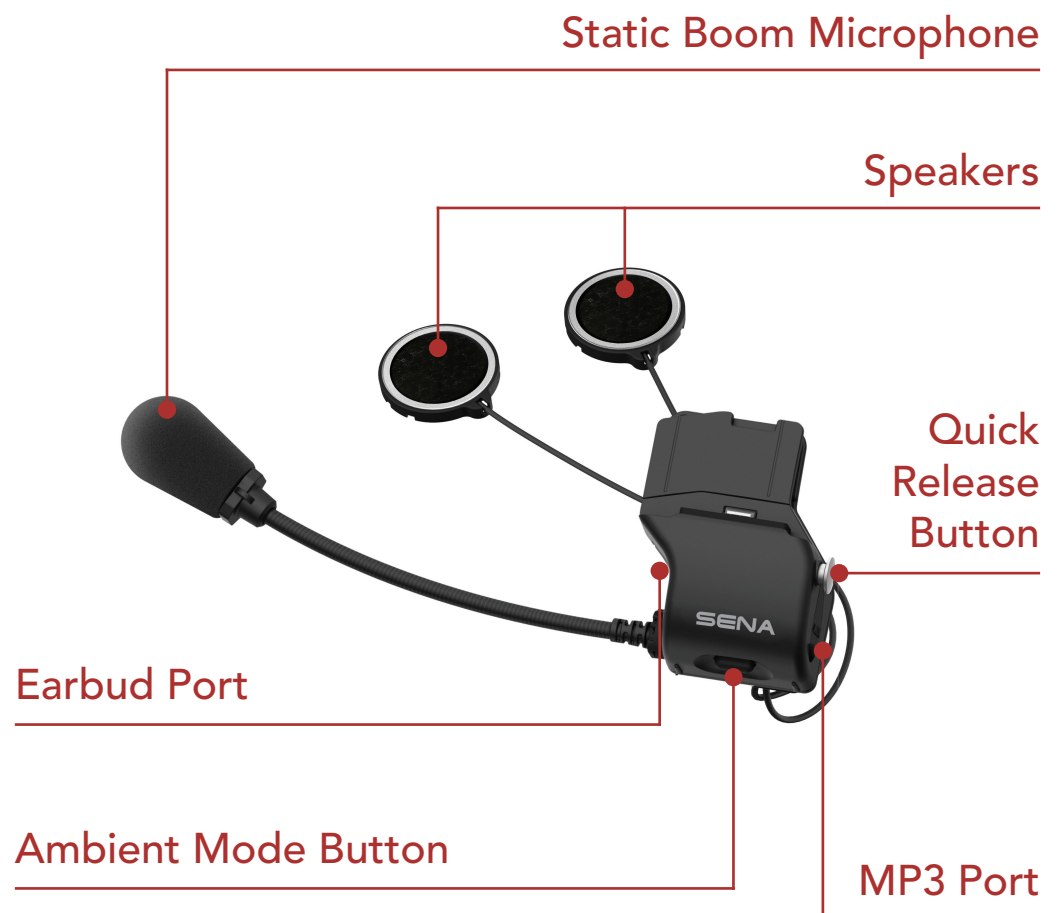







1. ABOUT THE MOTORCYCLE BLUETOOTH COMMUNICATION SYSTEM WITH MESH INTERCOM™

MENU

Product Details

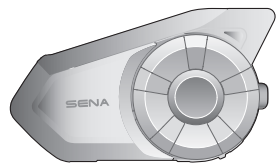
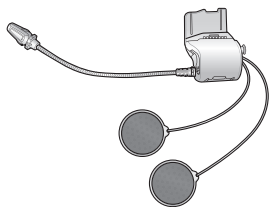
Package Contents

1.2 Package Contents

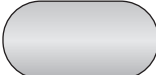
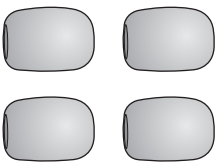
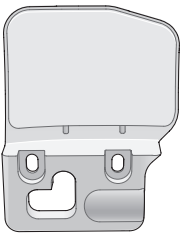
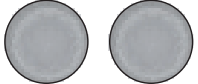
<ul style="list-style-type: none">• 30K Headset Main Unit	
<ul style="list-style-type: none">• Universal Helmet Clamp	
<ul style="list-style-type: none">• Wired Boom Microphone	
<ul style="list-style-type: none">• Wired Microphone	
<ul style="list-style-type: none">• Hook and Loop Fastener for Boom Microphone	
<ul style="list-style-type: none">• Hook and Loop Fastener for Wired Microphone	
<ul style="list-style-type: none">• Microphone Sponges	
<ul style="list-style-type: none">• Glued Surface Mounting Adapter	
<ul style="list-style-type: none">• Foam Speaker Covers	



1. ABOUT THE MOTORCYCLE BLUETOOTH COMMUNICATION SYSTEM WITH MESH INTERCOM™

MENU

Product
Details

Package
Contents

• Speaker Pads	
• Hook and Loop Fasteners for Speakers	
• Boom Microphone Holder	
• Hook and Loop Fastener for Holder	
• 2.5 to 3.5 mm Audio Cable	
• Rubber Pads	
• Allen Wrench	
• Speaker Port Cover	
• USB Power & Data Cable (Micro USB Type)	
• Cigarette Charger	



2. INSTALLING THE HEADSET ON YOUR HELMET

2.1 Helmet Installation

Helmet
Installation

Using the
Glued Surface
Mounting
Adapter

Switching the
Microphone

Earbuds

External Mesh
Intercom
Antenna

To securely install the headset on the helmet, please follow this procedure.

1. Insert the back plate of the clamp unit between the internal padding and the external shell of the helmet, and tighten the two screws.

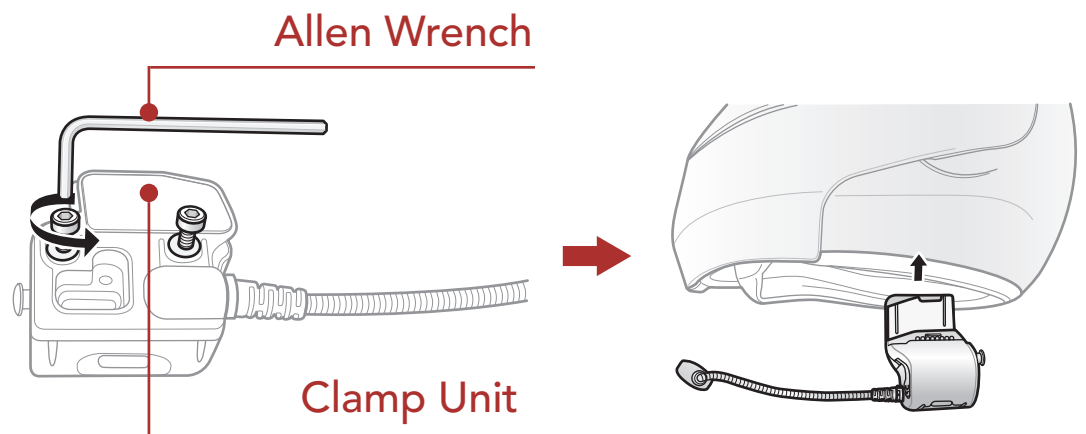

Note: Depending on the size and shape of your helmet, you may need to change the thickness of the rubber pad between the clamp plates using the two extra rubber pads in the box. To increase the overall thickness, attach the thinner one to the original rubber pad or replace the original rubber pad with the thicker one.

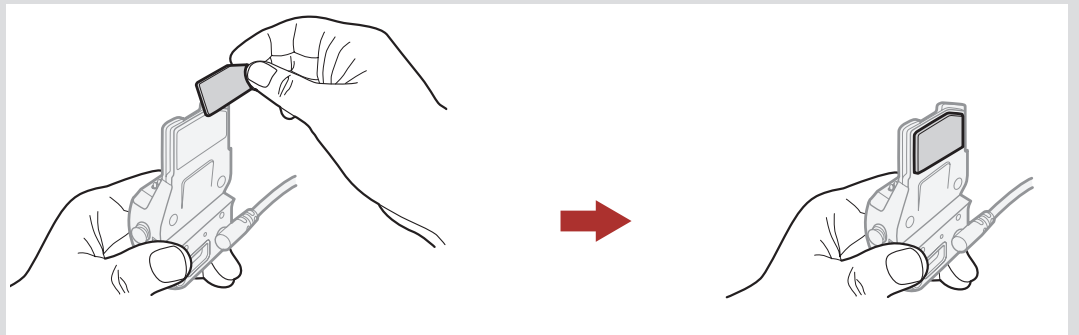



2. INSTALLING THE HEADSET ON YOUR HELMET

- Place the helmet speakers along with the hook and loop fasteners, centered to your ear, in the ear pockets of the helmet. If the helmet has deep ear pockets, you can use the speaker pads to place the speakers closer to your ears.

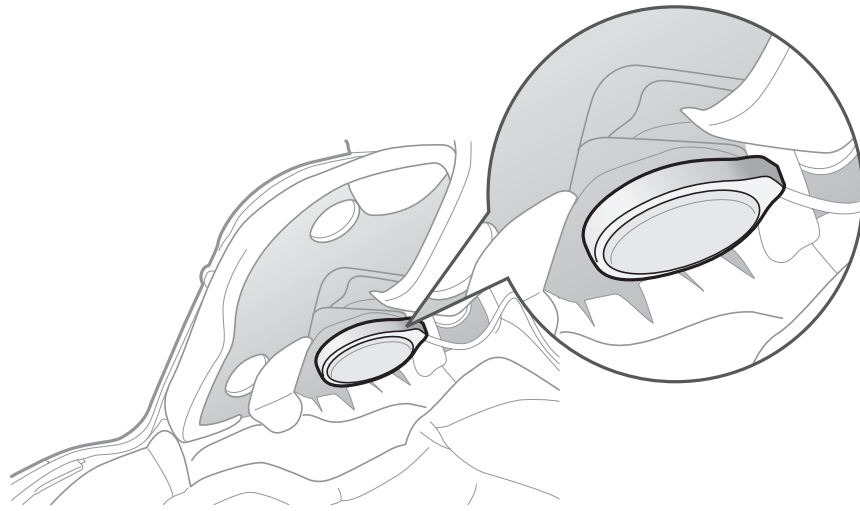

Helmet
Installation

Using the
Glued Surface
Mounting
Adapter

Switching the
Microphone

Earbuds

External Mesh
Intercom
Antenna

Note:

- The speaker with the shorter wire is for the left ear and the speaker with the longer one is for the right ear.
- To enhance the audio quality, you can make use of the foam speaker covers. Cover each speaker with the foam and attach the hook fastener at the back of the speaker. Then place the speakers in the helmet as described above. Foam covered speakers work most effectively when they are slightly touching your ears.

Foam Speaker Cover

Hook Fastener

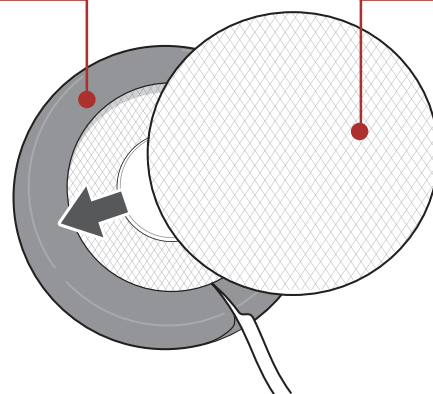



2. INSTALLING THE HEADSET ON YOUR HELMET

Helmet
Installation

Using the
Glued Surface
Mounting
Adapter

Switching the
Microphone

Earbuds

External Mesh
Intercom
Antenna

- Make sure that the microphone is located properly close to your mouth when you wear the helmet. Adjust the direction of the microphone so that the fin side of the microphone is facing outward, away from your lips.

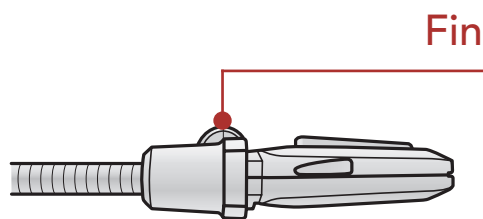

3. Attach the headset main unit to the clamp unit. Slide the main unit down onto the clamp unit until it clicks firmly into the bottom portion of the clamp unit.

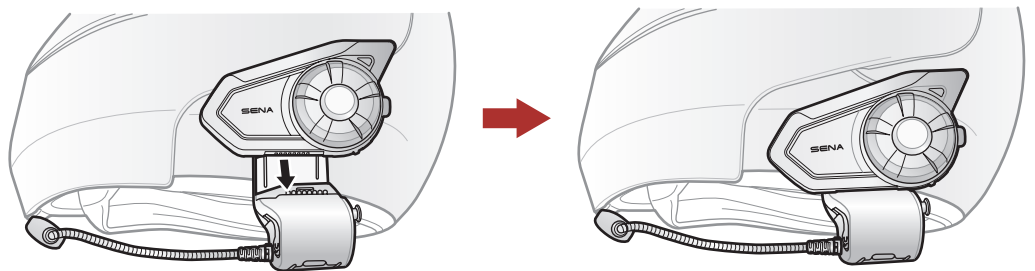

4. To remove the main unit from the clamp unit, press the Quick Release Button to slide it off the clamp unit.

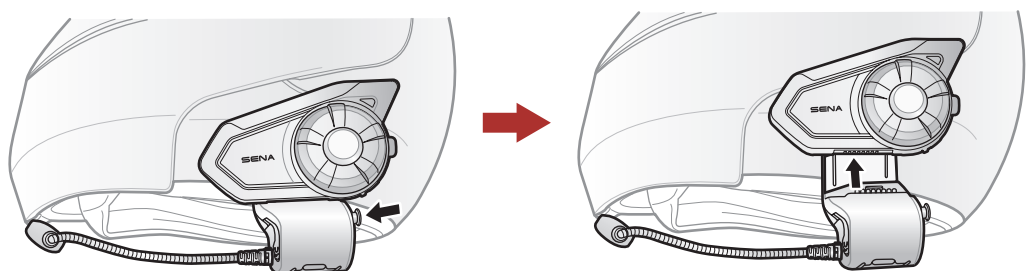



2. INSTALLING THE HEADSET ON YOUR HELMET

2.2 Using the Glued Surface Mounting Adapter

If you have any problem equipping the clamp unit on the helmet for any reason, you may use the glued surface mounting adapter to attach the clamp unit on the external surface of the helmet.

1. Remove the speaker unit.

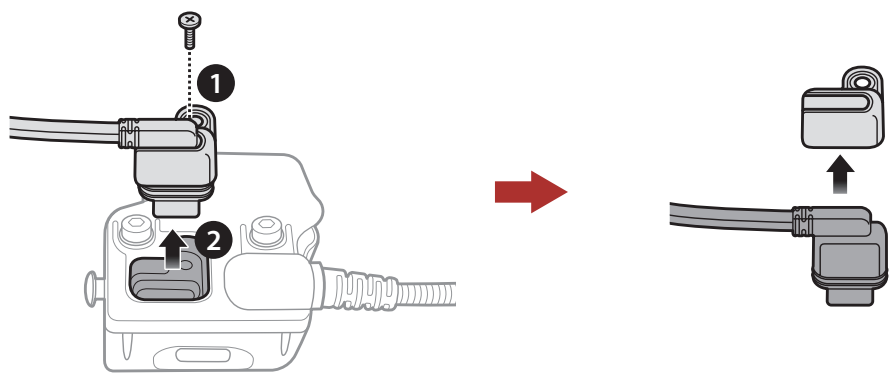

2. Remove the back plate.

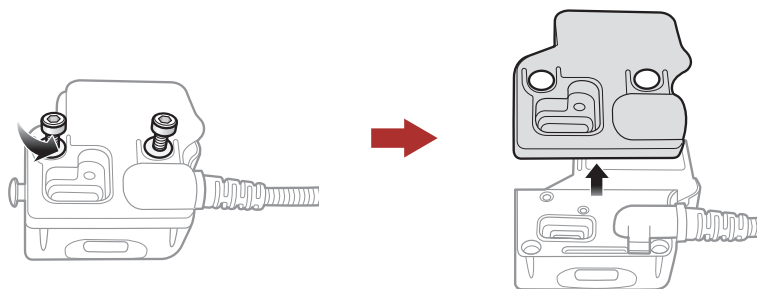

3. Remove the rubber pad and replace it with the thicker rubber pad included in the package.

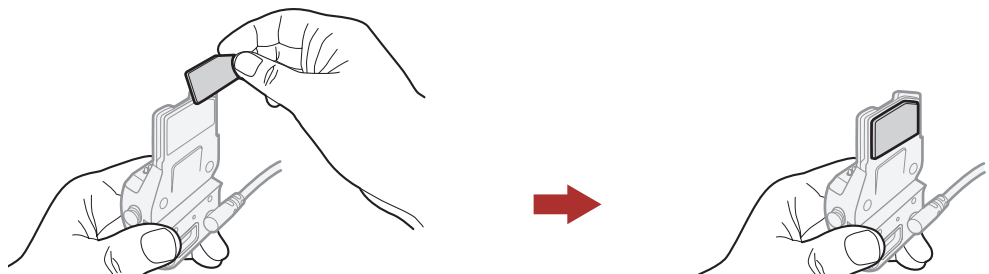

4. Hook on the adapter to the clamp unit then screw in the glued external adapter to the clamp unit.

Helmet
Installation

Using the
Glued Surface
Mounting
Adapter

Switching the
Microphone

Earbuds

External Mesh
Intercom
Antenna



2. INSTALLING THE HEADSET ON YOUR HELMET

5. Reconnect the speaker cable to the speaker port.

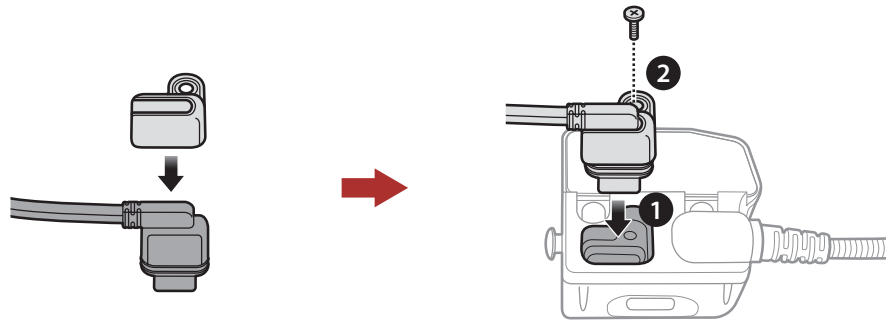

Helmet
Installation

Using the
Glued Surface
Mounting
Adapter

Switching the
Microphone

Earbuds

External Mesh
Intercom
Antenna

6. Locate a proper surface on the helmet to attach the unit then clean the helmet surface location with a moistened towel and allow to dry thoroughly.

7. Peel off the cover of the adhesive tape of the adapter and attach the unit on the proper surface of your helmet.

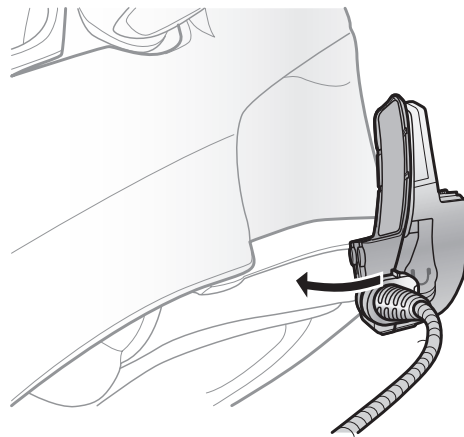

⚠ Caution: Sena recommends using the clamp unit. The glued surface mounting plate is provided for convenience, but is not the recommended mounting method. Sena is not responsible for its use.



2. INSTALLING THE HEADSET ON YOUR HELMET

2.3 Switching the Microphone

If you want to use a different microphone instead of the static boom microphone, please refer to the following steps.

1. Remove the back plate of the clamp unit.
2. Connect the microphone according to your helmet type.
3. Lock the microphone to the clamp.
4. Reattach the back plate to cover the microphone and the speaker port.

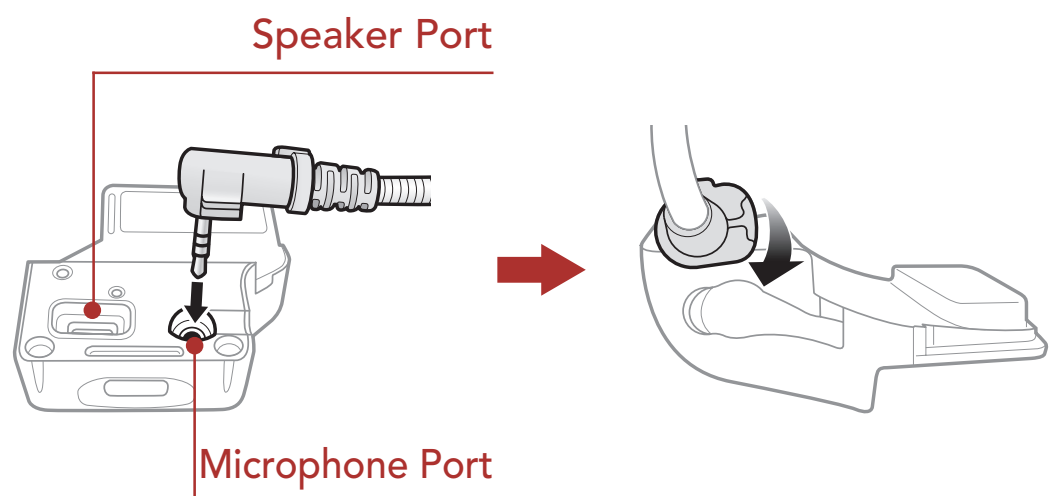

Helmet
Installation

Using the
Glued Surface
Mounting
Adapter

Switching the
Microphone

Earbuds

External Mesh
Intercom
Antenna



2. INSTALLING THE HEADSET ON YOUR HELMET

Helmet
Installation

Using the
Glued Surface
Mounting
Adapter

Switching the
Microphone

Earbuds

External Mesh
Intercom
Antenna

2.3.1 Wired Boom Microphone

When installing the included wired boom microphone, place the hook and loop fastener at the end of the boom microphone between the internal helmet cheek pad and the internal wall of the helmet shell. The boom microphone should be mounted so it is facing close to your mouth when you wear the helmet.

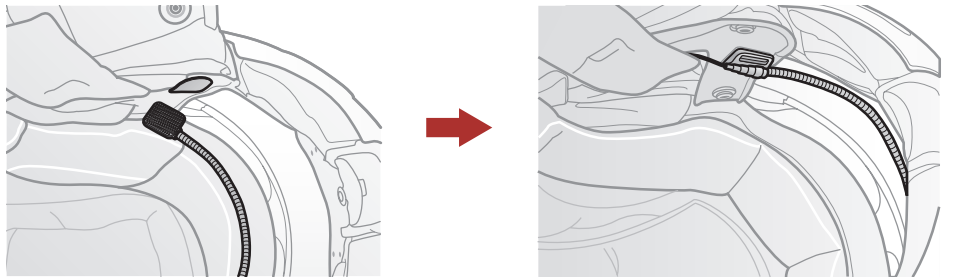

2.3.2 Wired Microphone

In case of the wired microphone, attach the enclosed hook and loop fastener for the wired microphone to the inside of the chin guard for full-face helmets. Place the wired microphone on the hook and loop fastener and connect it to the connector of the clamp unit.

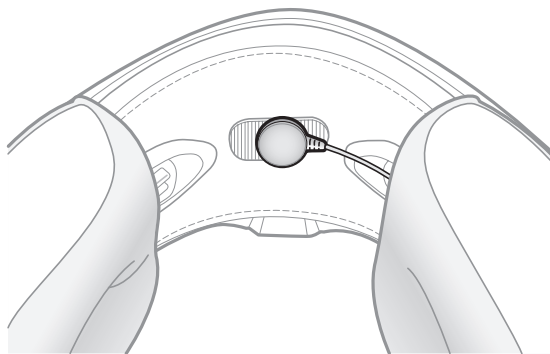



2. INSTALLING THE HEADSET ON YOUR HELMET

2.4 Earbuds

You can connect your earbuds to the clamp while having the speakers connected to the clamp. The sound of the earbuds will be active while the sound of the outer speakers becomes inactive.

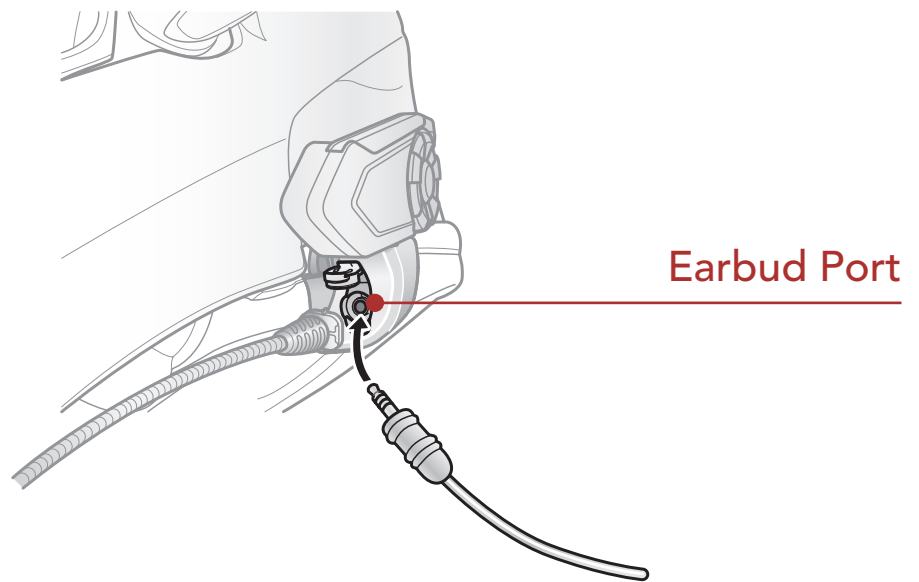

Helmet
Installation

Using the
Glued Surface
Mounting
Adapter

Switching the
Microphone

Earbuds

External Mesh
Intercom
Antenna

2.5 External Mesh Intercom Antenna

Pull the **Mesh Intercom** Antenna outwards slightly to unfold it.

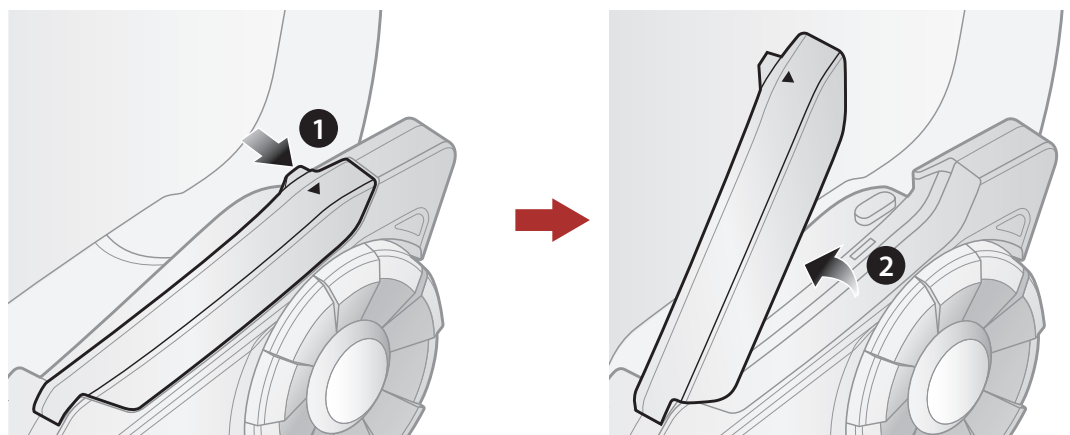



3. GETTING STARTED

3.1 Button Functions

Button Functions

Powering On and Off

Charging

Checking the Battery Level

Volume Adjustment

Downloadable Sena Software

Configuration Menu

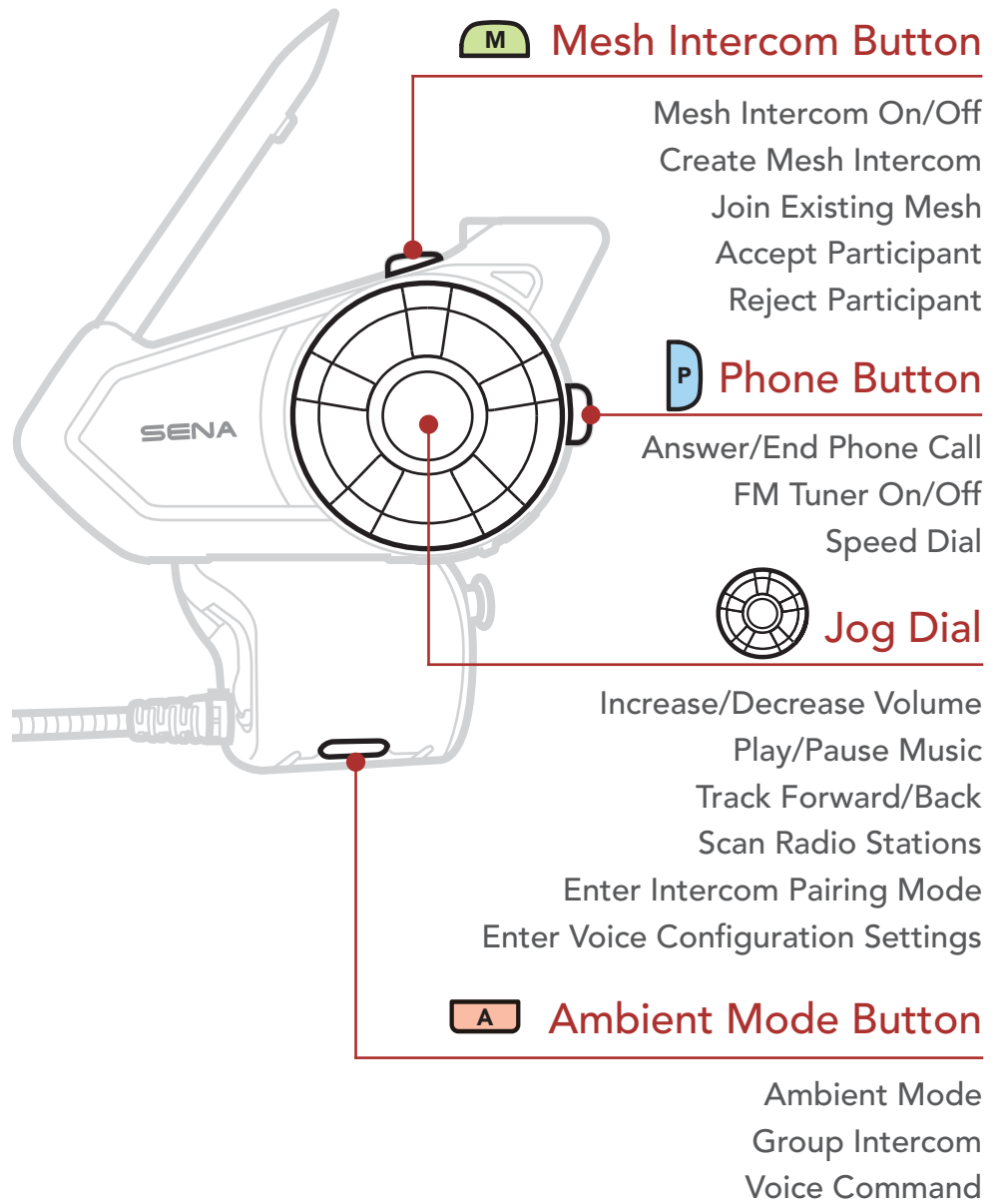



3. GETTING STARTED

3.2 Powering On and Off

Press and hold the **Jog Dial** and **Phone Button** at the same time to turn the headset on or off.

Button Functions

Powering On and Off

Charging

Checking the Battery Level

Volume Adjustment

Downloadable Sena Software

Configuration Menu

Powering On

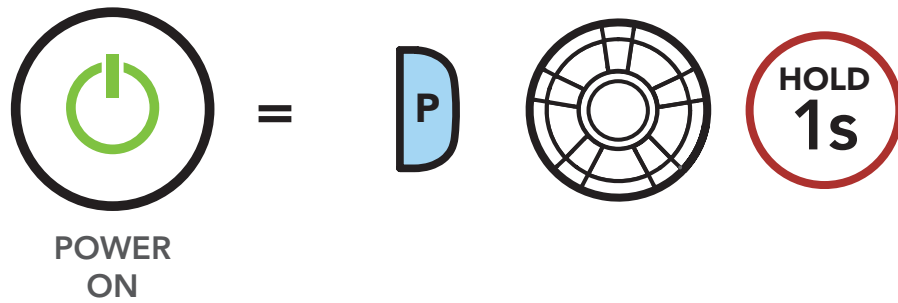

"Preparing headset"

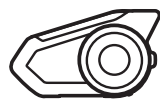

"Hello"

Powering Off



Note: If the Voice Command setting is disabled, the "Hello" voice prompt will be heard instantly after powering on the headset. Please refer to **Section 11: "Voice Command"** for more details.



3. GETTING STARTED

3.3 Charging

Charging the Headset

Button
Functions

Powering On
and Off

Charging

Checking the
Battery Level

Volume
Adjustment

Downloadable
Sena Software

Configuration
Menu

DC Power Charging &
Firmware Upgrade Port

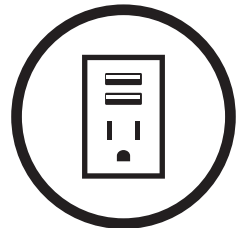

The headset will be fully charged in about 1.5 hours. (The charging time may vary depending on the charging method.)

Note:

- The headset includes a **Fast Charging** feature which allows it to charge quickly over a short period of time. For example, a user can get 5 hours of talk time after charging the headset for 20 minutes.
- Any 3rd party USB charger can be used with Sena products if the charger is approved by either the FCC, CE, IC or other locally approved agencies that Sena accepts.



3. GETTING STARTED

3.4 Checking the Battery Level

There are two ways to check battery level:

1. Visually, with LEDs when powering on.

Battery Level - Visual Method

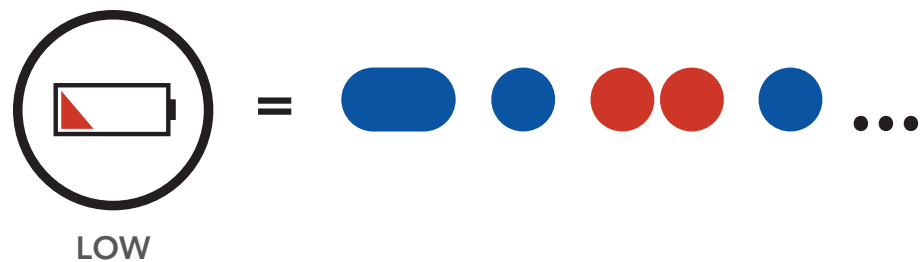
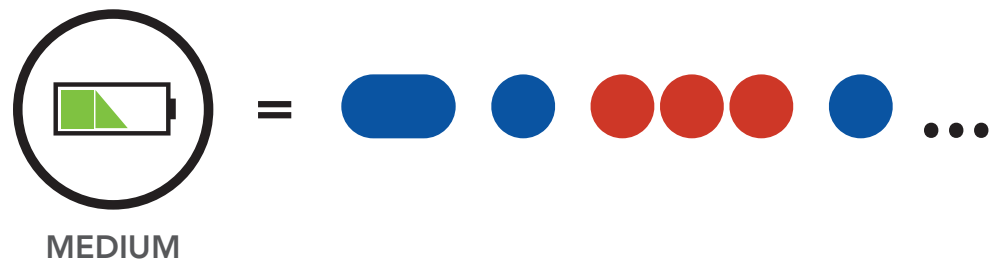
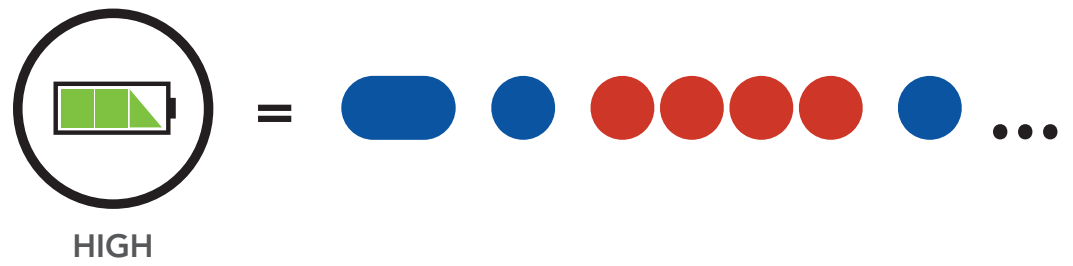
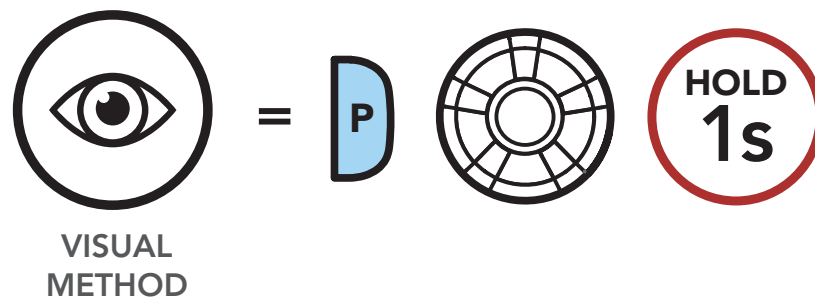

Button Functions

Powering On and Off

Charging

Checking the Battery Level

Volume Adjustment

Downloadable Sena Software

Configuration Menu



3. GETTING STARTED

2. Audible method: press and hold the **Phone Button** and **Jog Dial** for more than 5 seconds as the headset powers on. A prompt will announce the remaining battery level.

Battery Level - Audible Method

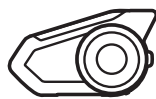
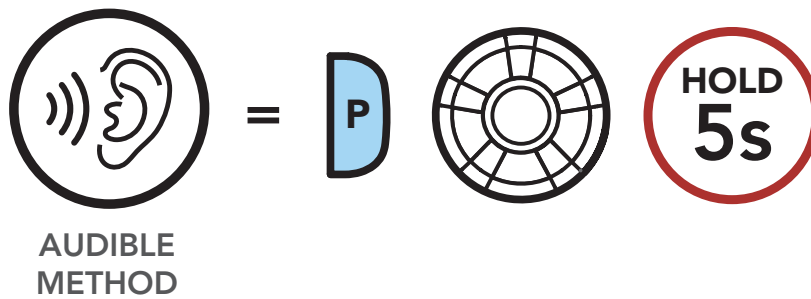

"Battery level high/medium/low"

Note: When the battery is low while in use, you will hear a voice prompt saying **"Low battery"**.

Button
Functions

Powering On
and Off

Charging

Checking the
Battery Level

Volume
Adjustment

Downloadable
Sena Software

Configuration
Menu



3. GETTING STARTED

3.5 Volume Adjustment

You can raise or lower the volume by rotating the **Jog Dial** clockwise or counterclockwise. Volume is set and maintained independently at different levels for each audio source (i.e., phone, intercom), even when the headset is rebooted.

Button Functions

Powering On and Off

Charging

Checking the Battery Level

Volume Adjustment

Downloadable Sena Software

Configuration Menu

Volume Up

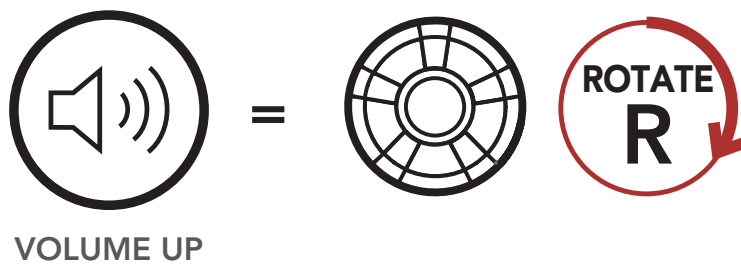

VOLUME UP

Volume Down

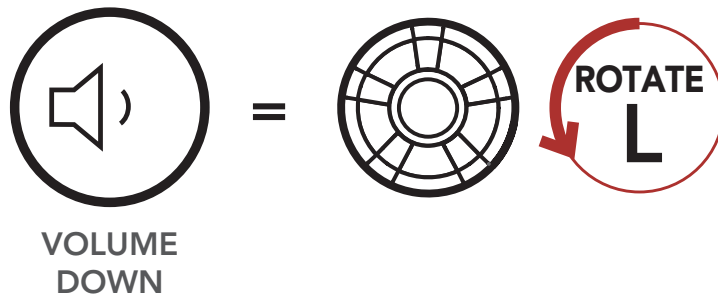

VOLUME DOWN



3. GETTING STARTED

3.6 Downloadable Sena Software

Button
Functions

Powering On
and Off

Charging

Checking the
Battery Level

Volume
Adjustment

Downloadable
Sena Software

Configuration
Menu

3.6.1 Sena Device Manager

The **Sena Device Manager** allows you to upgrade the firmware and configure its settings directly from your PC or Apple computer. Using this software, you can assign speed dial presets, FM radio station presets and more. For more information on downloading the **Sena Device Manager**, please visit sena.com.

[Click Here to Visit sena.com](http://sena.com)

3.6.2 Sena Smartphone App

The **Sena Smartphone App** allows you to configure the headset settings, as well as access the User's Guide and Quick Start Guides. To do so, pair your mobile phone with your headset (please refer to **Section 4: "Pairing the Headset with Other Bluetooth Devices"** for more details). Run the **Sena Smartphone App** and configure the settings directly from your smartphone. You can download the **Sena Smartphone App** for Android and Apple operating systems.





3. GETTING STARTED

Sena Software Configuration Menu

Button Functions

Powering On and Off

Charging

Checking the Battery Level

Volume Adjustment

Downloadable Sena Software

Configuration Menu

Configuration Setting	Enable/Disable or Execute
Speed Dial	Execute
Intercom-Audio Overlay Sensitivity	Execute
Audio Overlay Volume Management	Enable/Disable
Audio Boost	Enable/Disable
Smart Volume Control	Enable/Disable
VOX Phone	Enable/Disable
VOX Intercom	Enable/Disable
HD Intercom	Enable/Disable
Intercom VOX Sensitivity	Execute
Guest Mode	Enable/Disable
Voice Prompt	Enable/Disable
Voice Command	Enable/Disable
RDS AF Setting	Enable/Disable
FM Station Guide	Enable/Disable
Sidetone	Enable/Disable
Advanced Noise Control	Enable/Disable



3. GETTING STARTED

3.7 Configuration Menu

The headset can be configured by following a series of voice prompts. Further details about each of these settings will be explained on the following pages.

1. To access the **Configuration Menu**, press and hold the **Jog Dial** for **10 seconds** until you hear the voice prompt, **"Configuration menu."**

Accessing the Configuration Menu

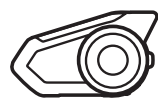
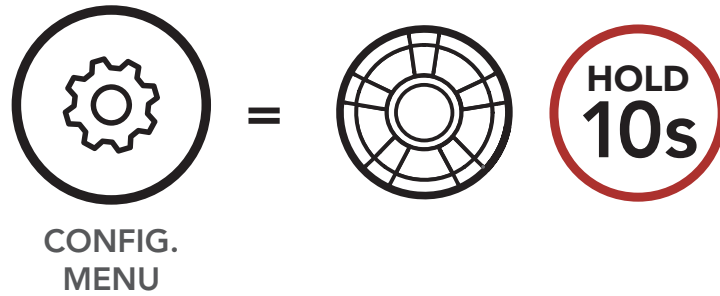

"Configuration menu"

Button
Functions

Powering On
and Off

Charging

Checking the
Battery Level

Volume
Adjustment

Downloadable
Sena Software

Configuration
Menu



3. GETTING STARTED

2. Rotate the **Jog Dial** clockwise or counterclockwise to navigate between the menus. You will hear voice prompts for each menu item. The list of functions is shown in the **"Headset Configuration Menu"** on page 30.

Navigating Forward through the Menu

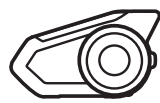
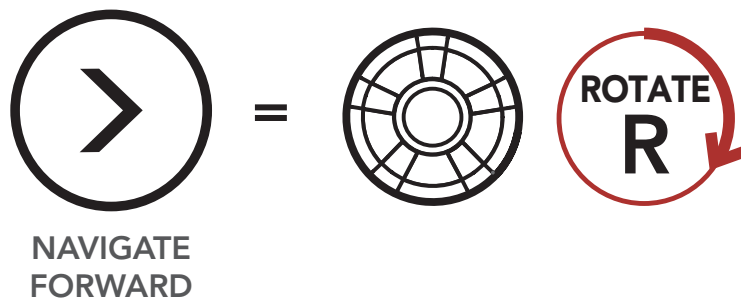

"[Menu prompt]"

Navigating Backward through the Menu

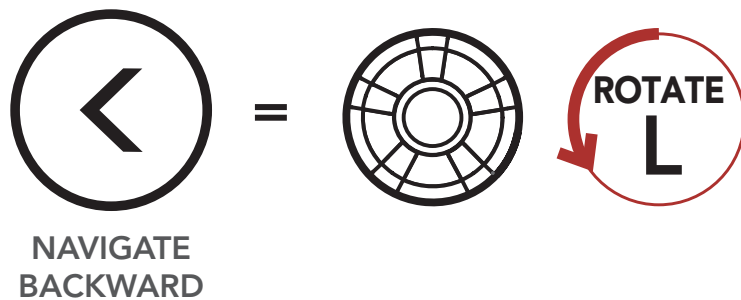

"[Menu prompt]"

Button Functions

Powering On and Off

Charging

Checking the Battery Level

Volume Adjustment

Downloadable Sena Software

Configuration Menu



3. GETTING STARTED

3. You can enable the feature or execute the command by tapping the **Phone Button**.

Execute Menu Options

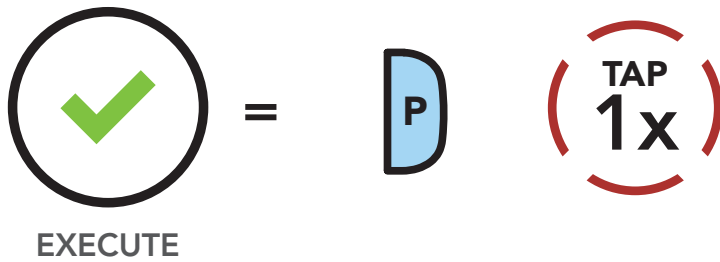

Button Functions

Powering On and Off

Charging

Checking the Battery Level

Volume Adjustment

Downloadable Sena Software

Configuration Menu

Headset Configuration Menu

Rotate the Jog Dial clockwise or counterclockwise	Tap the Phone Button
Delete All Pairings	Execute
Remote Control Pairing	Execute
Universal Intercom Pairing	Execute
Exit Configuration	Execute

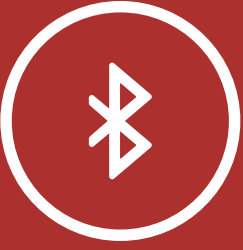

4. PAIRING THE HEADSET WITH OTHER BLUETOOTH DEVICES

Mobile Phone

Additional Mobile Phones, MP3 Player or Sena SR10 Two-Way Radio Adapter

Advanced Selective Pairing: Hands-Free or A2DP Stereo

GPS Pairing

When using the headset with other Bluetooth devices for the first time, they'll need to be "paired." This enables them to recognize and communicate with one another whenever they're within range.

The headset can pair with multiple Bluetooth devices such as a mobile phone, GPS, MP3 player or Sena SR10 Two-Way Radio Adapter via **Mobile Phone Pairing, Second Mobile Phone Pairing and GPS Pairing**. The headset can also be paired with up to three other Sena headsets.

Pairs with up to three Sena Headsets

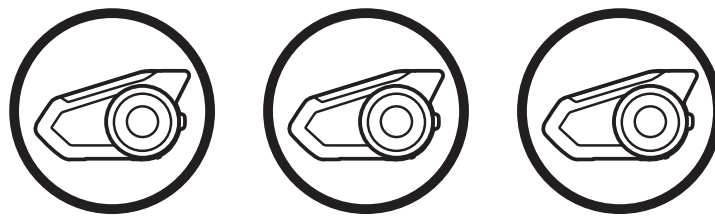

Also pairs with:



Mobile Phone



MP3 Player



GPS Devices

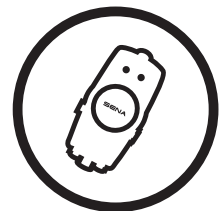

Sena SR10

Note: Bluetooth Specifications: Bluetooth 2.4 GHz ~ 2.48 GHz / max output power 0.097mW

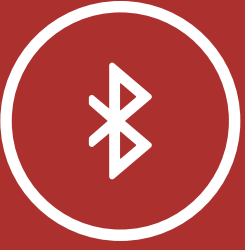

4. PAIRING THE HEADSET WITH OTHER BLUETOOTH DEVICES

- Mobile Phone
- Additional Mobile Phones, MP3 Player or Sena SR10 Two-Way Radio Adapter
- Advanced Selective Pairing: Hands-Free or A2DP Stereo
- GPS Pairing

4.1 Mobile Phone

1. Execute **Phone Pairing** by holding down the **Phone Button** for **5 seconds**.

Mobile Phone Pairing

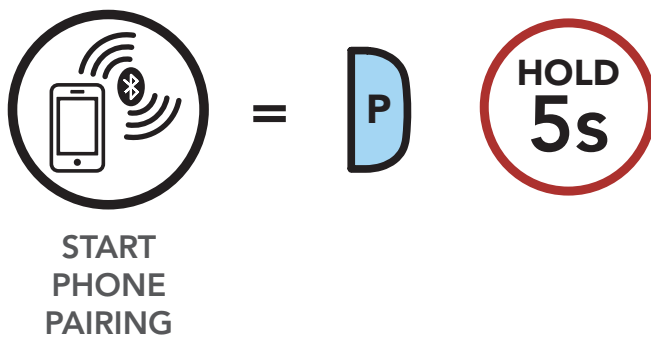

"Phone pairing"

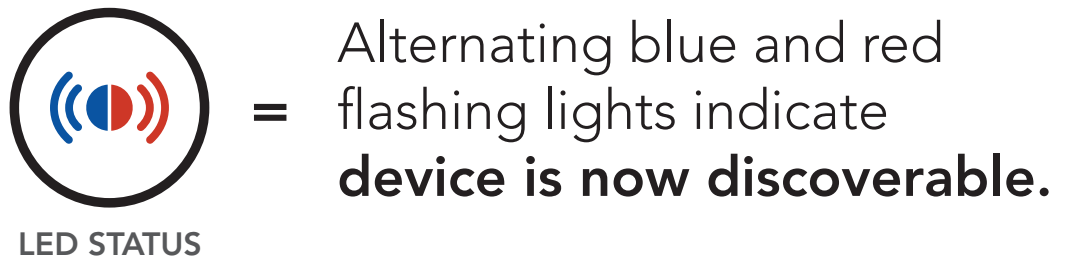

2. With your mobile phone in Bluetooth-pairing mode, select the headset in the list of devices detected.
3. If your mobile phone asks for a PIN, enter 0000.

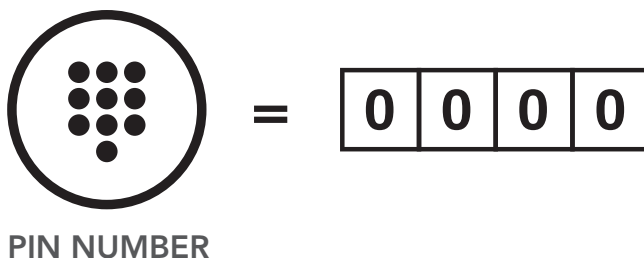

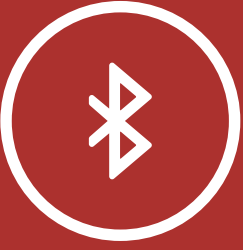

4. PAIRING THE HEADSET WITH OTHER BLUETOOTH DEVICES

Mobile Phone

Additional Mobile Phones, MP3 Player or Sena SR10 Two-Way Radio Adapter

Advanced Selective Pairing: Hands-Free or A2DP Stereo

GPS Pairing

4.2 Additional Mobile Phones, MP3 Player or Sena SR10 Two-Way Radio Adapter

1. Execute **Second Mobile Phone Pairing** by holding down the **Jog Dial** for **5 seconds**. Tap the **Phone Button** once within **2 seconds**.

Second Mobile Phone Pairing

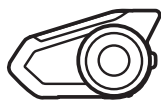
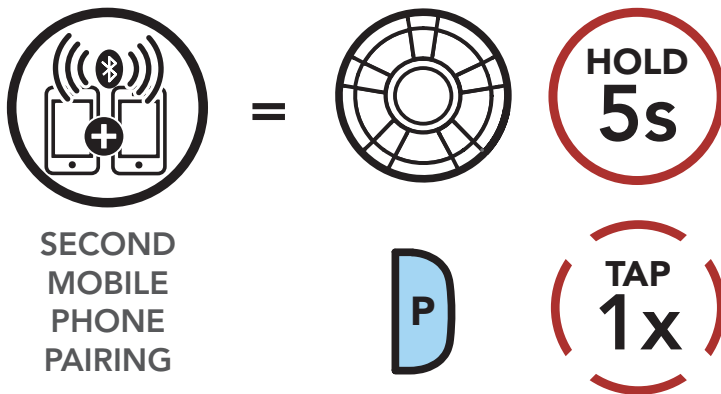

"Second mobile phone pairing"



LED STATUS

= Blue flashing lights indicates **device is now discoverable.**

2. With your mobile phone in Bluetooth-pairing mode, select the headset in the list of devices detected.
3. If your mobile phone asks for a PIN, enter 0000.

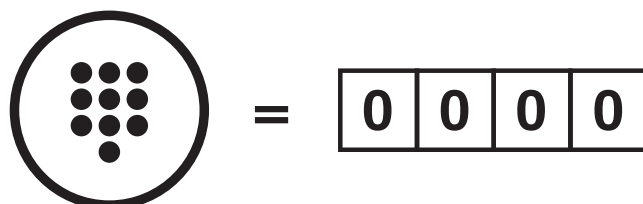

PIN NUMBER

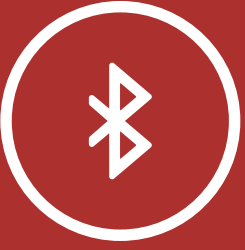

4. PAIRING THE HEADSET WITH OTHER BLUETOOTH DEVICES

Mobile Phone

Additional Mobile Phones, MP3 Player or Sena SR10 Two-Way Radio Adapter

Advanced Selective Pairing: Hands-Free or A2DP Stereo

GPS Pairing

4.3 Advanced Selective Pairing: Hands-Free or A2DP Stereo

Phone Pairing allows the headset to establish two Bluetooth profiles: **Hands-Free** or **A2DP Stereo**.

Advanced Selective Pairing allows the headset to separate the profiles to enable connection with two devices.

4.3.1 Phone Selective Pairing - Hands-Free Profile

1. Execute **Phone Selective Pairing** by holding down the **Phone Button** for **5 seconds**. Tap the **Phone Button** once within **2 seconds**.

Phone Selective Pairing

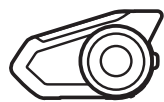
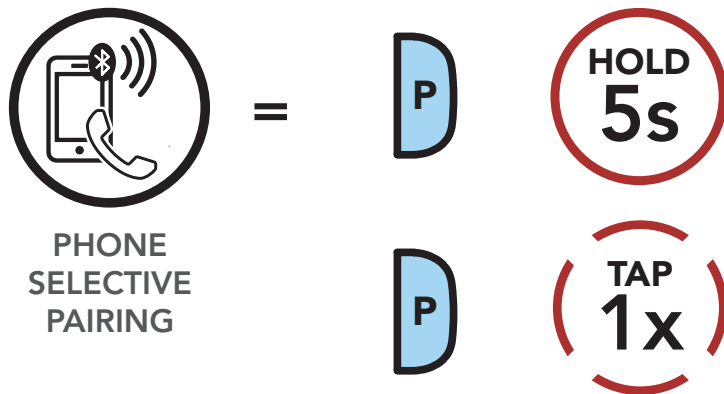

"Phone selective pairing"



LED STATUS

= Blue flashing lights indicates **device is now discoverable**.

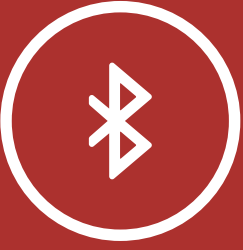

4. PAIRING THE HEADSET WITH OTHER BLUETOOTH DEVICES

Mobile Phone

Additional Mobile Phones, MP3 Player or Sena SR10 Two-Way Radio Adapter

Advanced Selective Pairing: Hands-Free or A2DP Stereo

GPS Pairing

2. With your mobile phone in Bluetooth-pairing mode, select the headset in the list of devices detected.
3. If your mobile phone asks for a PIN, enter 0000.

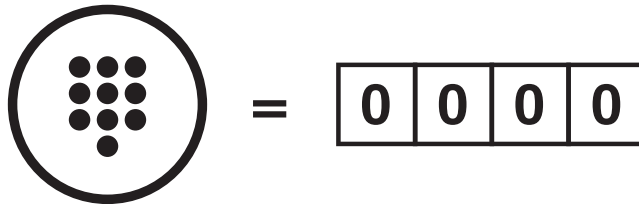

PIN NUMBER

4.3.2 Media Selective Pairing - A2DP Profile

1. Execute **Media Selective Pairing** by holding down the **Phone Button** for **5 seconds**. Tap the **Jog Dial** once within **2 seconds**.

Media Selective Pairing

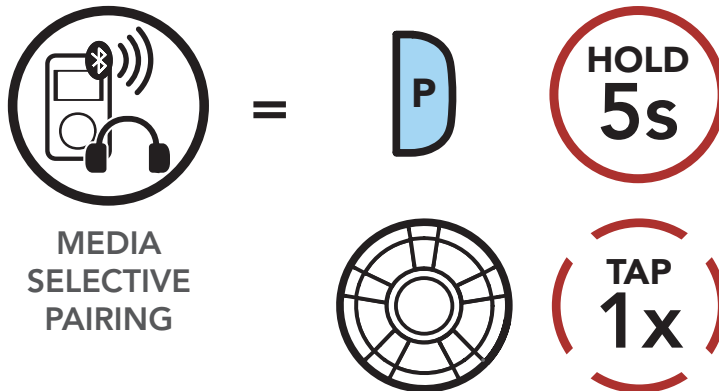

"Media selective pairing"



LED STATUS

= Red flashing lights indicate **device is now discoverable**.

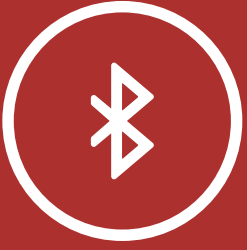

4. PAIRING THE HEADSET WITH OTHER BLUETOOTH DEVICES

Mobile Phone

Additional Mobile Phones, MP3 Player or Sena SR10 Two-Way Radio Adapter

Advanced Selective Pairing: Hands-Free or A2DP Stereo

GPS Pairing

2. With your mobile phone in Bluetooth-pairing mode, select the headset in the list of devices detected.
3. If your mobile phone asks for a PIN, enter 0000.

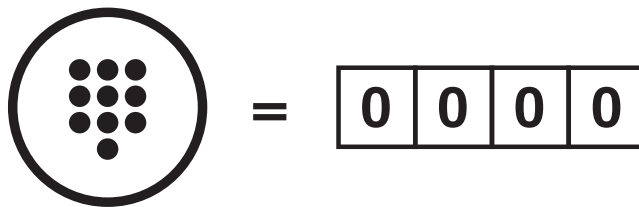

PIN NUMBER



4. PAIRING THE HEADSET WITH OTHER BLUETOOTH DEVICES

Mobile Phone
Additional Mobile Phones, MP3 Player or Sena SR10 Two-Way Radio Adapter

Advanced Selective Pairing: Hands-Free or A2DP Stereo

GPS Pairing

4.4 GPS Pairing

1. Execute **GPS Pairing** by holding down the **Jog Dial** for **5 seconds**. Within **2 seconds**, tap the **Phone Button** once to hear the voice prompt, **"Second mobile phone pairing"**. Again within **2 seconds**, tap the **Phone Button** to hear the voice prompt, **"GPS pairing"**.

GPS Pairing

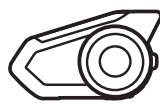
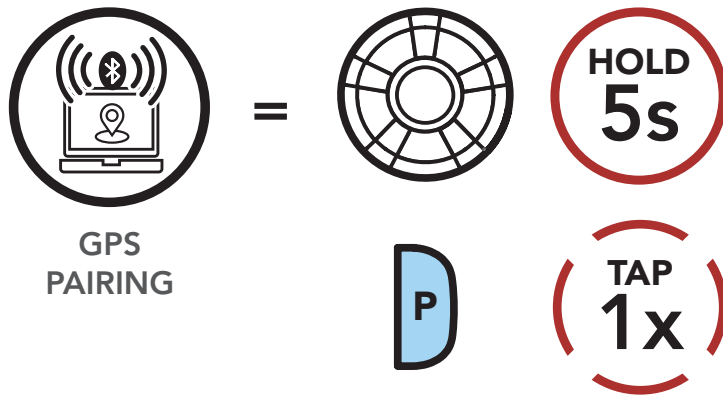

"Second mobile phone pairing"

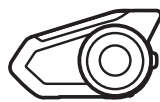

"GPS pairing"



LED STATUS

= Green flashing lights indicates device is now discoverable.

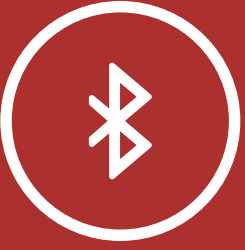

4. PAIRING THE HEADSET WITH OTHER BLUETOOTH DEVICES

Mobile Phone

Additional Mobile Phones, MP3 Player or Sena SR10 Two-Way Radio Adapter

Advanced Selective Pairing: Hands-Free or A2DP Stereo

GPS Pairing

2. With your Bluetooth device on the GPS navigation screen, select the headset in the list of devices detected.
3. If your Bluetooth device asks for a PIN, enter 0000.

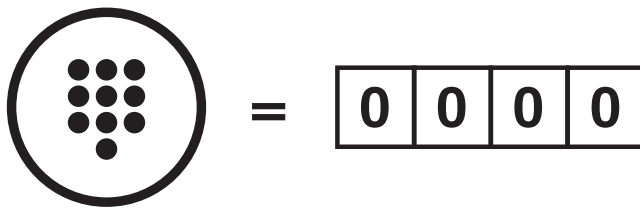

PIN NUMBER

Note: If you pair your GPS device via GPS Pairing, its instruction will not interrupt your Mesh Intercom conversations, but overlay with them. Bluetooth intercom conversations will be interrupted by GPS instructions.



5. MOBILE PHONE USAGE

5.1 Making and Answering Calls

Making and Answering Calls

Speed Dialing

VOX Phone

Answer a Call

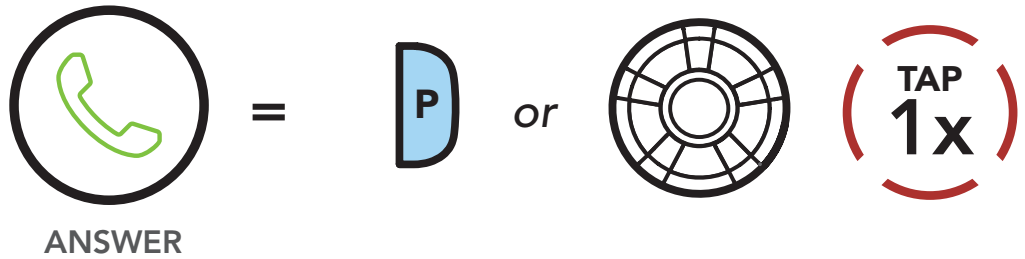

End a Call

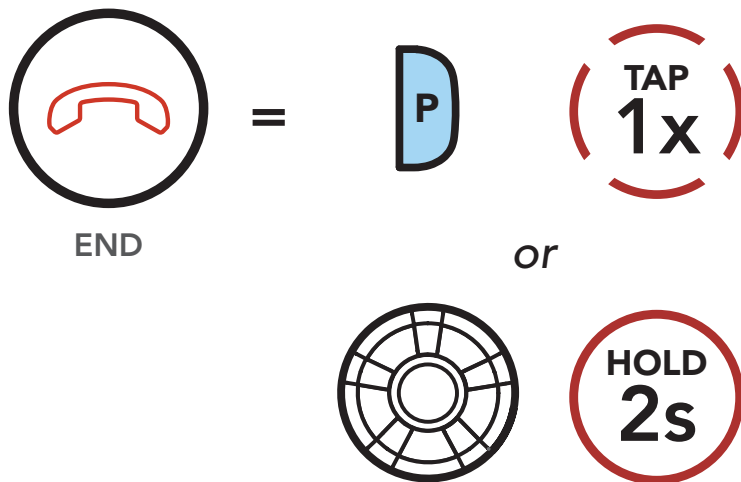

Reject a Call

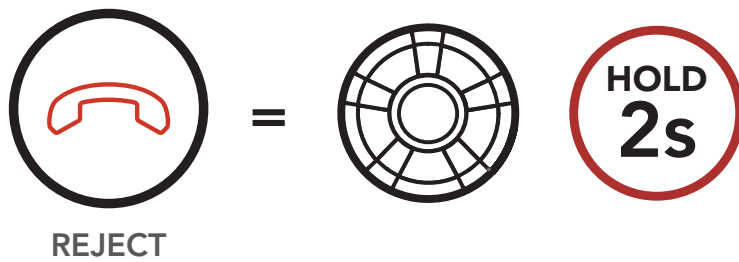

Make a Call with Voice Dialer

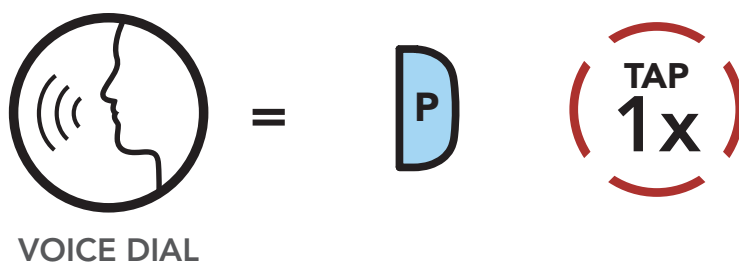

Note: If you have a GPS device connected, you will not hear its voice navigations during a phone call.



5. MOBILE PHONE USAGE

5.2 Speed Dialing

Making and
Answering
Calls

Speed Dialing

VOX Phone

5.2.1 Assigning Speed Dial Presets

Speed Dial Presets could be assigned in the settings menu, accessible through **Sena Device Manager** or **Sena Smartphone App**.

5.2.2 Using Speed Dial Presets

1. Tap the **Phone Button** twice to enter into the **Speed Dial** menu. You will hear the voice prompt, **"Speed dial."**

Enter Speed Dial Mode

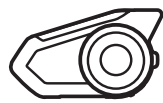
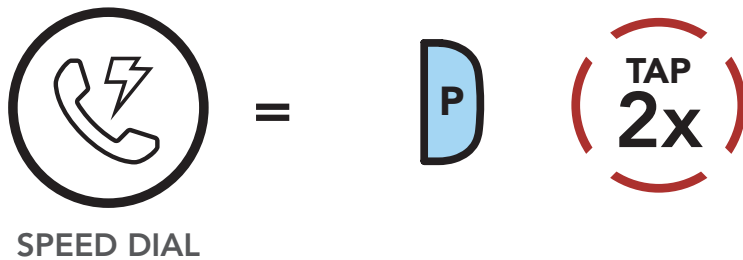

"Speed dial"

2. Rotate the **Jog Dial** clockwise or counterclockwise to navigate between the **Speed Dial Presets**.

Navigate Forward through Speed Dial Preset Numbers

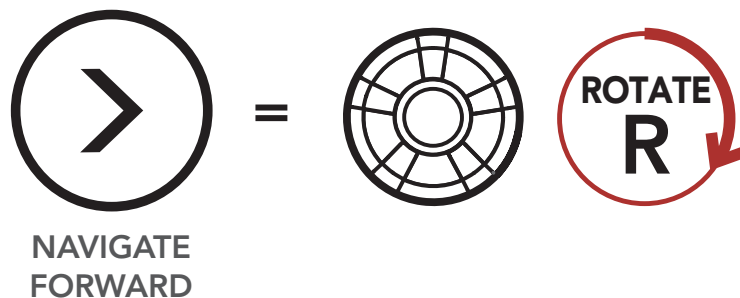

Navigate Backward through Speed Dial Preset Numbers

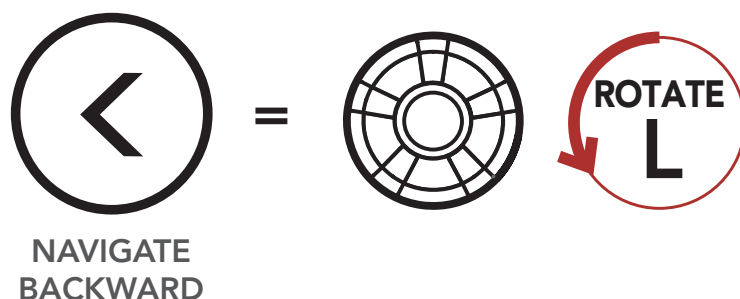



5. MOBILE PHONE USAGE

Making and Answering Calls

Speed Dialing

VOX Phone

3. To call one of your **Speed Dial Presets**, tap the **Phone Button** when you hear the prompt, **"Speed dial (#)."**

Call a Speed Dial Preset Number

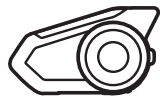
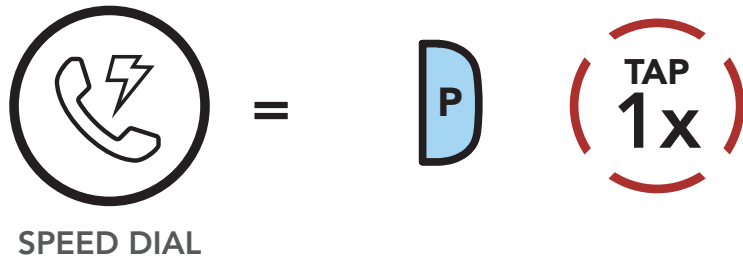

"Speed dial (#)"

4. To redial the last number called, tap the **Phone Button** when you hear the prompt, **"Last number redial."**

Redial Last Number

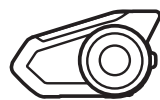
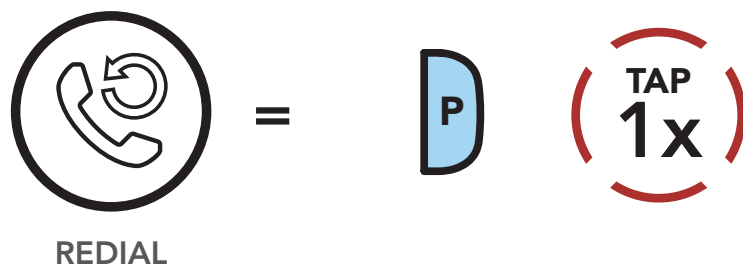

"Last number redial"



5. MOBILE PHONE USAGE

5.3 VOX Phone (Default: Enable)

Making and
Answering
Calls

An **VOX Phone** setting can be found in the settings menu, accessible through **Sena Device Manager** or **Sena Smartphone App**.

Speed Dialing

With **VOX Phone** enabled, you can answer incoming calls by simply saying a word loudly enough, unless you are connected to intercom. For example, when you hear a series of beeps for an incoming call, you can answer the phone by saying **"Hello"** or any other word loudly. If this mode is disabled, you have to tap the **Jog Dial** or the **Phone Button** to answer an incoming call.

VOX Phone



6. STEREO MUSIC

6.1 Playing Music with Bluetooth Devices

Playing Music with Bluetooth Devices

- To play or pause music, press and hold the **Jog Dial** for **1 second** until you hear a double beep.

Play/Pause

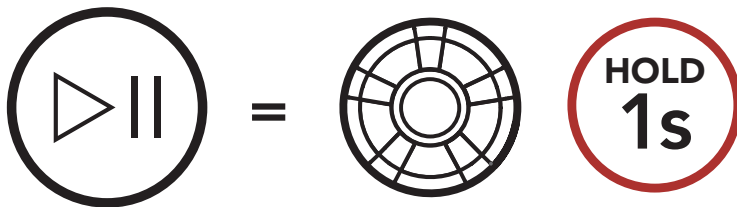

PLAY/PAUSE

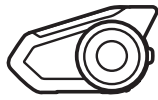

"[Beep, Beep]"

Playing Music with non-Bluetooth Devices

Music Sharing

Audio Boost

Smart Volume Control

- To adjust the volume, rotate the **Jog Dial** clockwise or counterclockwise.

Volume Up

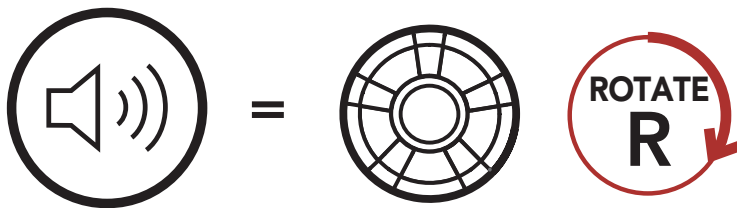

VOLUME UP

Volume Down

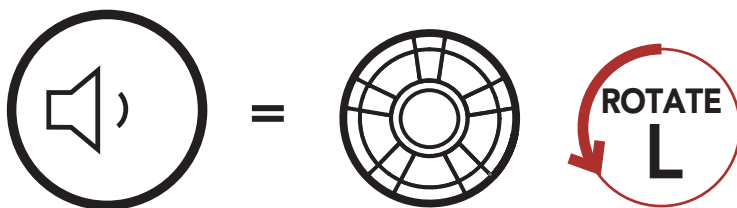

VOLUME DOWN



6. STEREO MUSIC

3. To track forward or back, rotate while pressing the **Jog Dial** clockwise or counterclockwise.

Playing Music with Bluetooth Devices

Playing Music with non-Bluetooth Devices

Music Sharing

Audio Boost

Smart Volume Control

Track Forward

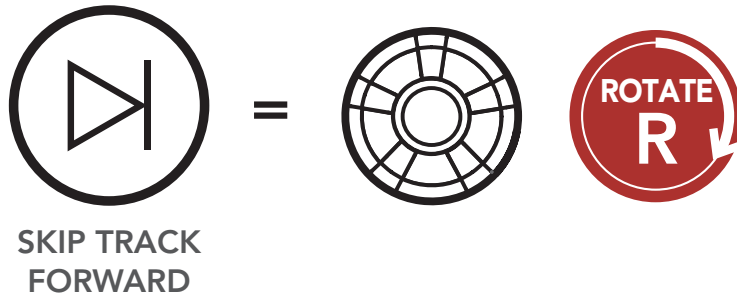

Track Backward

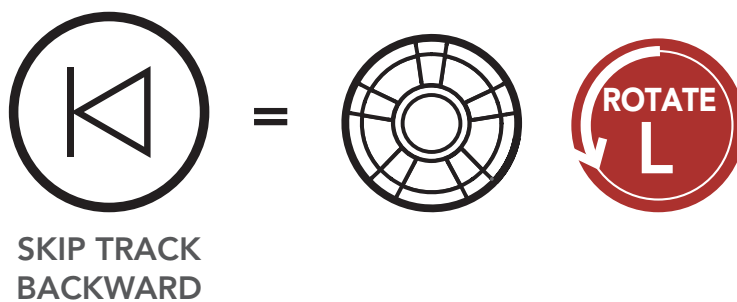

6.2 Playing Music with non-Bluetooth Devices

You can play music that is stored on non-Bluetooth devices such as MP3 players. To connect your device to the headset, plug the enclosed 2.5 to 3.5 mm audio cable into the AUX ports, both on the headset and on your device.

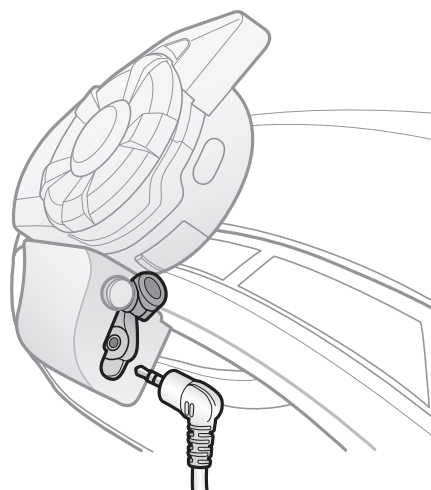



6. STEREO MUSIC

To adjust the volume, rotate the **Jog Dial** clockwise or counterclockwise. You can also adjust the volume directly on the connected device.

Playing Music with Bluetooth Devices

Playing Music with non-Bluetooth Devices

Music Sharing

Audio Boost

Smart Volume Control

Volume Up

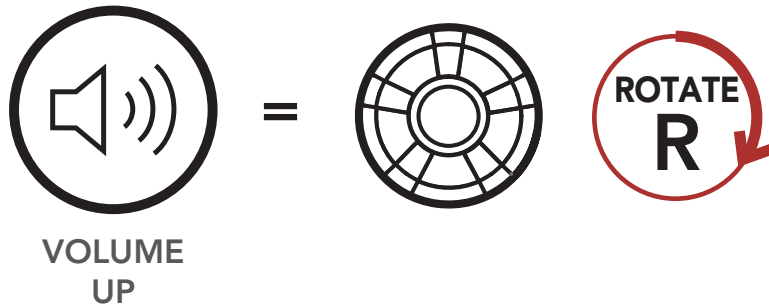

Volume Down

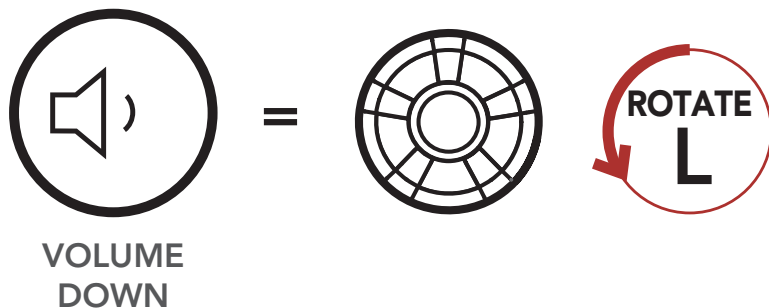

6.3 Music Sharing

You can start sharing music with one intercom friend using Bluetooth stereo music during a two-way intercom conversation and one participant of a Mesh. Both you and your intercom friend can remotely control music playback such as track forward and track back. If you start sharing music while Bluetooth intercom and Mesh Intercom are running at the same time, then music shared during Bluetooth intercom will take priority over music shared during Mesh Intercom. The Creator will send a request message to a headset connected during Mesh Intercom and will share music with the first participant that accepts the request.



6. STEREO MUSIC

Bluetooth Intercom Music Sharing

Playing Music with Bluetooth Devices

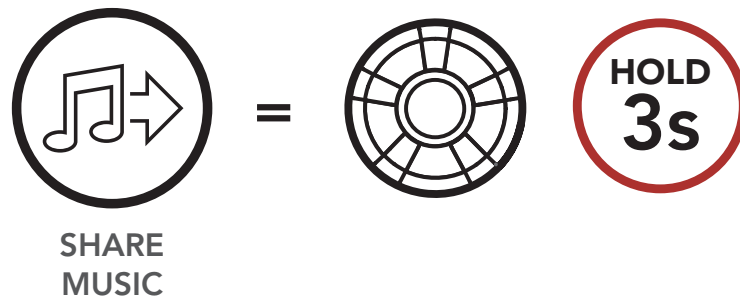

Playing Music with non-Bluetooth Devices

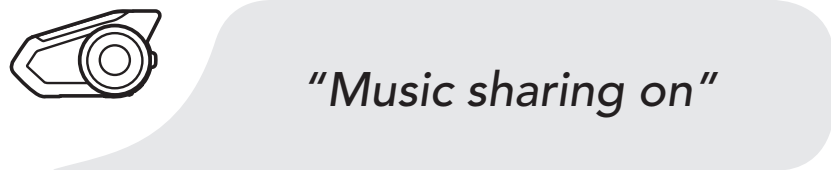

Music Sharing

Audio Boost

Mesh Intercom Music Sharing [Creator]

Smart Volume Control

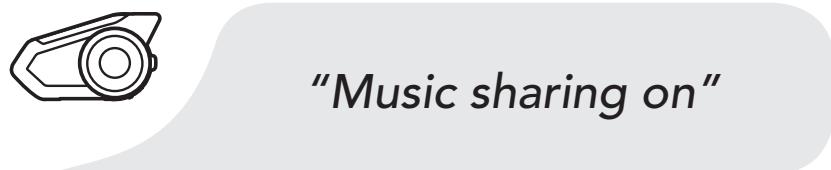
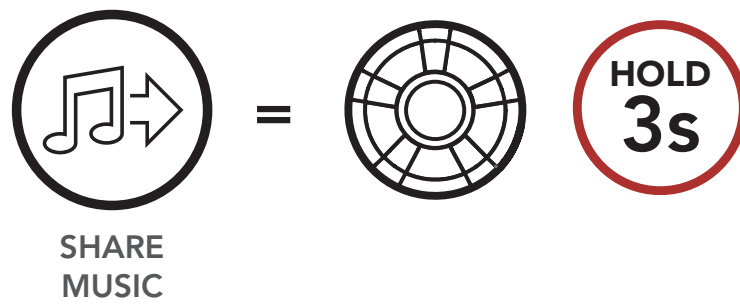

[Participant]

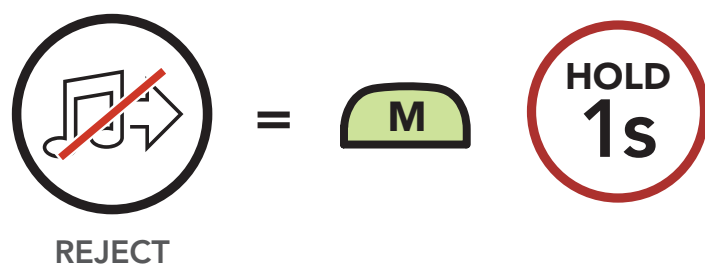
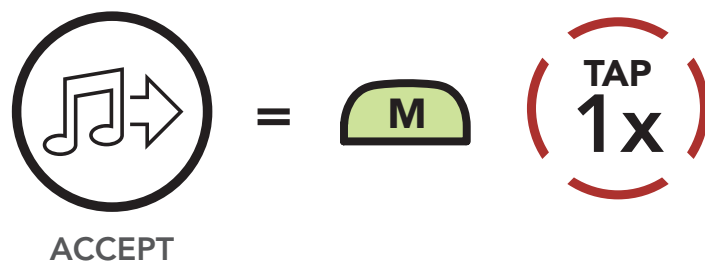
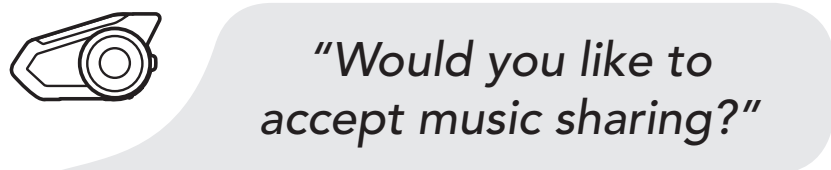



6. STEREO MUSIC

6.4 Audio Boost (Default: Disable)

Playing
Music with
Bluetooth
Devices

An **Audio Boost** setting can be found in the settings menu, accessible through **Sena Device Manager** or **Sena Smartphone App**.

Playing Music
with non-
Bluetooth
Devices

Enabling **Audio Boost** increases the maximum volume limit. Disabling **Audio Boost** reduces the maximum volume limit while delivering more balanced sound.

Music Sharing

6.5 Smart Volume Control (Default: Disable)

Audio Boost

A **Smart Volume Control** setting can be found in the settings menu, accessible through **Sena Device Manager** or **Sena Smartphone App**.

Smart Volume
Control

Enabling **Smart Volume Control** automatically changes the level of the speaker volume based on the level of the environment noise. You can enable it by setting the sensitivity to low, medium or high.



7. BLUETOOTH INTERCOM SETUP

7.1 Intercom Pairing

Up to three people can communicate via intercom with the headset simply by pairing their headsets.

Pairing with Intercom Friends

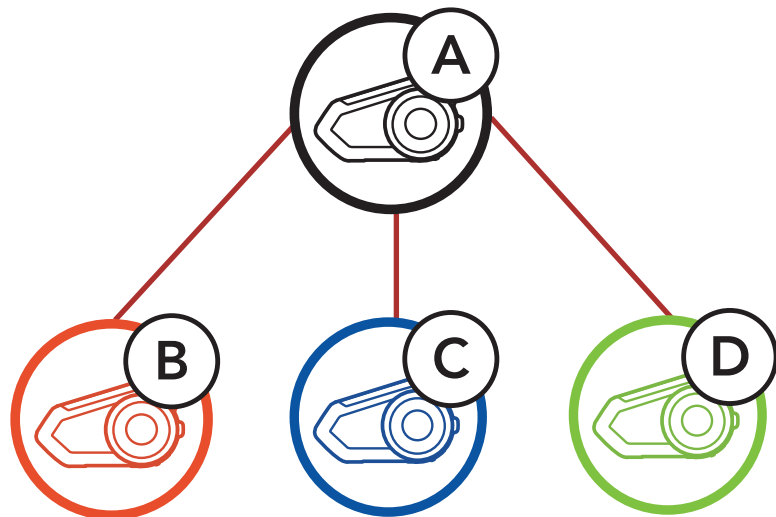

1. Press and hold the **Jog Dials** of two headsets for **5 seconds** until you hear the voice prompt, **"Intercom pairing"**.

Pairing Headset A with Headset B

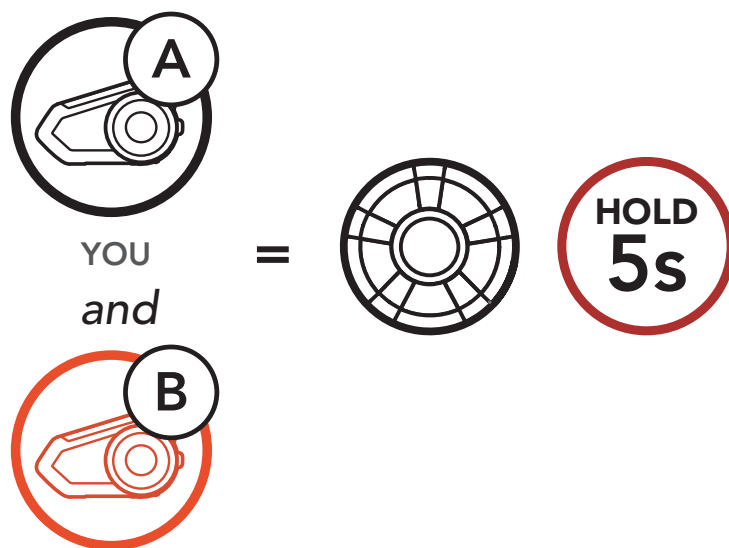

"Intercom pairing"



=

Red flashing lights indicate device is now discoverable.

LED STATUS

- Intercom Pairing
- Two-Way Intercom
- Multi-Way Intercom
- Three-Way Conference Phone Call with Intercom Users
- Group Intercom
- Universal Intercom
- VOX Intercom
- Intercom VOX Sensitivity
- HD Intercom
- Advanced Noise Control™



7. BLUETOOTH INTERCOM SETUP

2. Tap the **Jog Dial** on either headset and wait until the LEDs of both turn blue.

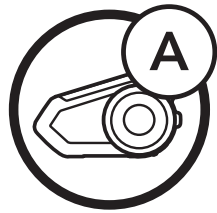

YOU

=



or

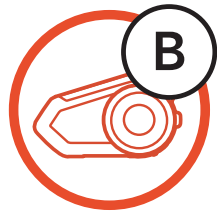

B



LED STATUS

=

Flashing blue LED confirms intercoms are paired.

Intercom Pairing

Two-Way Intercom

Multi-Way Intercom

Three-Way Conference Phone Call with Intercom Users

Group Intercom

Universal Intercom

VOX Intercom

Intercom VOX Sensitivity

HD Intercom

Advanced Noise Control™



7. BLUETOOTH INTERCOM SETUP

3. Repeat steps 1 and 2 to pair with **Intercom Friends C & D**.

Last-Come, First-Served

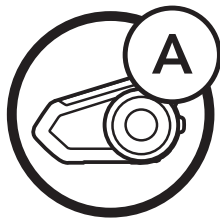

YOU

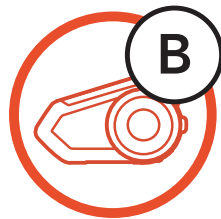

Intercom Friend 1

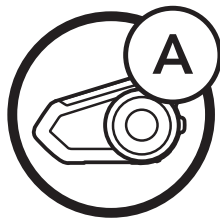

YOU

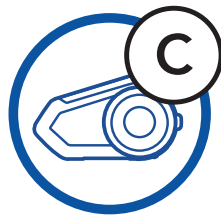

Intercom Friend 1

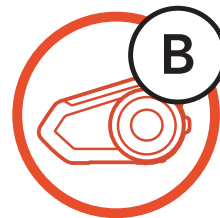

Intercom Friend 2

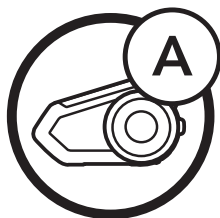

YOU

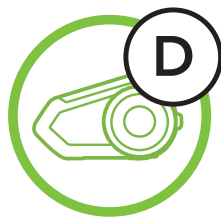

Intercom Friend 1

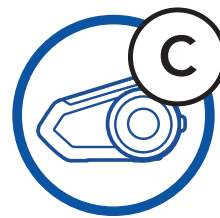

Intercom Friend 2

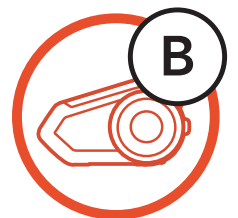

Intercom Friend 3

- Intercom Pairing
- Two-Way Intercom
- Multi-Way Intercom
- Three-Way Conference Phone Call with Intercom Users
- Group Intercom
- Universal Intercom
- VOX Intercom
- Intercom VOX Sensitivity
- HD Intercom
- Advanced Noise Control™



7. BLUETOOTH INTERCOM SETUP

7.2 Two-Way Intercom

You can start or end an intercom conversation with an Intercom Friend by tapping the **Jog Dial**.

1. Tap once for Intercom **Friend 1**.

Start/End with Intercom Friend 1

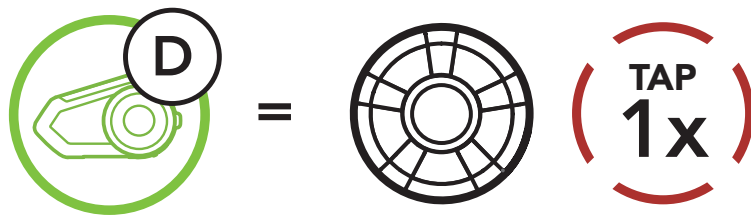

2. Tap twice for Intercom **Friend 2**.

Start/End with Intercom Friend 2

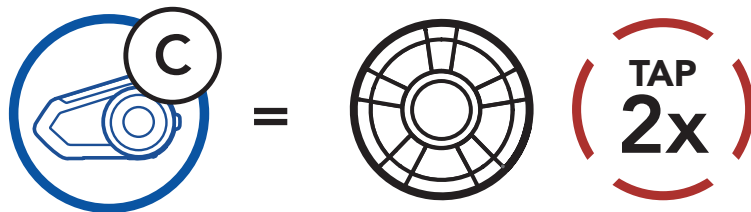

3. Tap three times for Intercom **Friend 3**.

Start/End with Intercom Friend 3

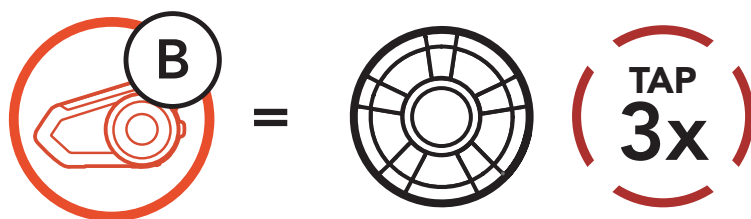

Intercom
Pairing

Two-Way
Intercom

Multi-Way
Intercom

Three-Way
Conference
Phone Call
with Intercom
Users

Group
Intercom

Universal
Intercom

VOX Intercom

Intercom VOX
Sensitivity

HD Intercom

Advanced
Noise
Control™



7. BLUETOOTH INTERCOM SETUP

7.3 Multi-Way Intercom

Intercom Pairing

Two-Way Intercom

Multi-Way Intercom

Three-Way Conference Phone Call with Intercom Users

Group Intercom

Universal Intercom

VOX Intercom

Intercom VOX Sensitivity

HD Intercom

Advanced Noise Control™

Multi-Way Intercom enables conference-call-style conversations with up to three **Intercom Friends** at the same time. While **Multi-Way Intercom** is in progress, mobile phone connection is temporarily disconnected. However, as soon as **Multi-Way Intercom** terminates, the mobile phone connection will be reestablished.

7.3.1 Starting a Three-Way Intercom Conference

You (A) can have a **Three-Way Intercom Conference** with two other **Intercom Friends (B & C)** by establishing two intercom connections simultaneously.

1. Pair your headset (A) with those of two other **Intercom Friends (B & C)**. Please refer to **Section 7.1: "Intercom Pairing"** for pairing instructions.

Pair with Intercom Friends B & C

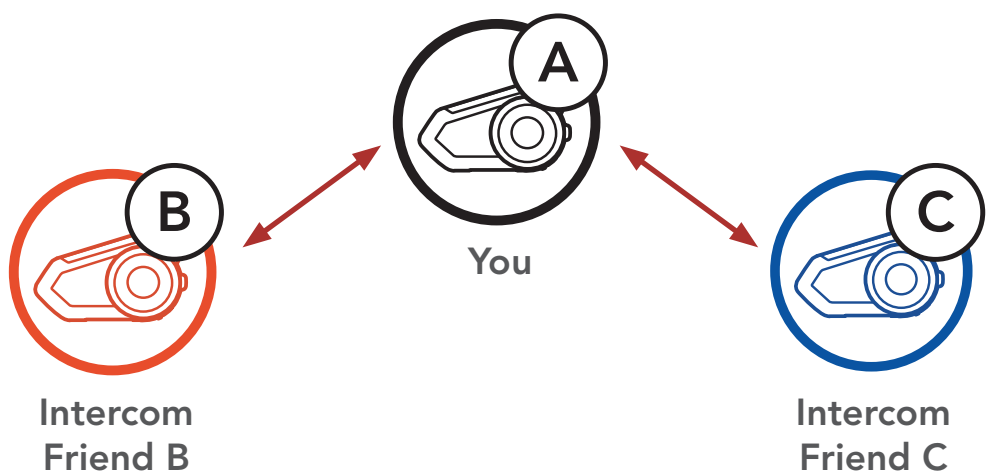



7. BLUETOOTH INTERCOM SETUP

Intercom Pairing

Two-Way Intercom

Multi-Way Intercom

Three-Way Conference Phone Call with Intercom Users

Group Intercom

Universal Intercom

VOX Intercom

Intercom VOX Sensitivity

HD Intercom

Advanced Noise Control™

2. Start an intercom conversation with one of the two friends in your intercom group. For example, **you (A)** may start an intercom conversation with the **Intercom Friend (B)**. Or, **Intercom Friend (B)** may start an intercom call with **you (A)**.

Starting an Intercom Conversation with Intercom Friend B

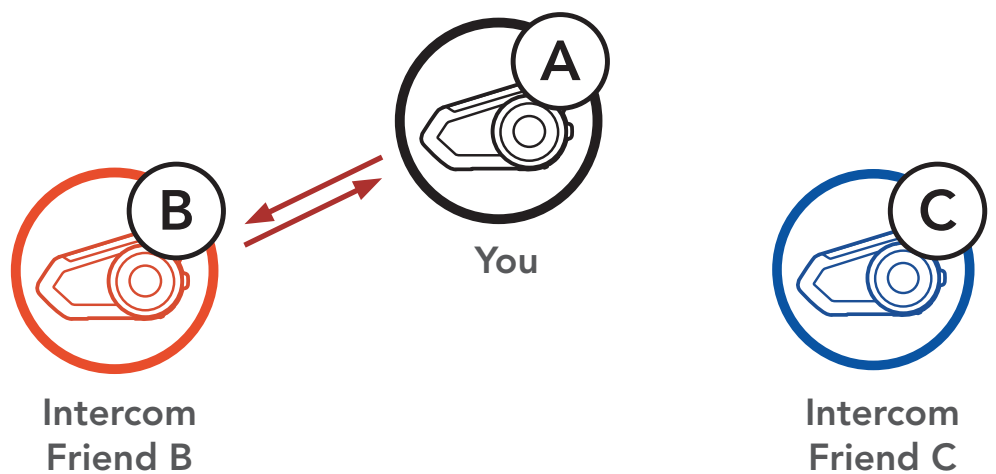

3. Then, **you (A)** can call the second **Intercom Friend (C)**, or the second **Intercom Friend (C)** may join the intercom by making an intercom call to **you (A)**.

Starting an Intercom Conversation with Intercom Friend C

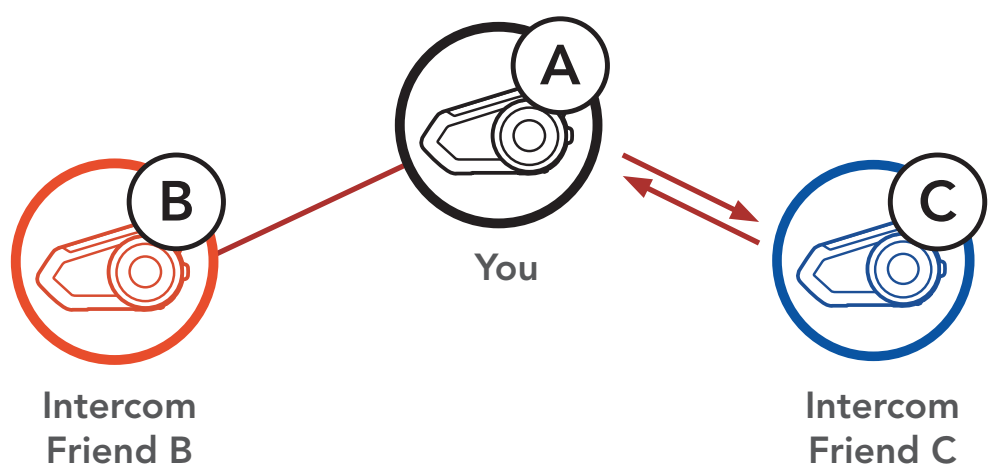



7. BLUETOOTH INTERCOM SETUP

4. Now **you (A)** and two **Intercom Friends (B & C)** are having a **Three-Way Intercom Conference**.

Three-Way Intercom

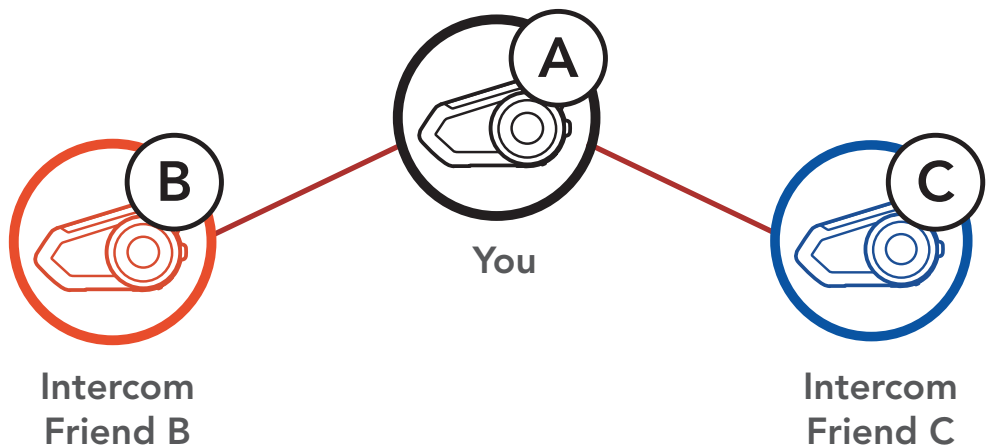

7.3.2 Starting a Four-Way Intercom Conference

With three **Intercom Friends** connected, a new participant **(D)** can make it a **Four-Way Intercom Conference** by making an intercom call to either **(B)** or **(C)**.

Starting a Four-Way Intercom

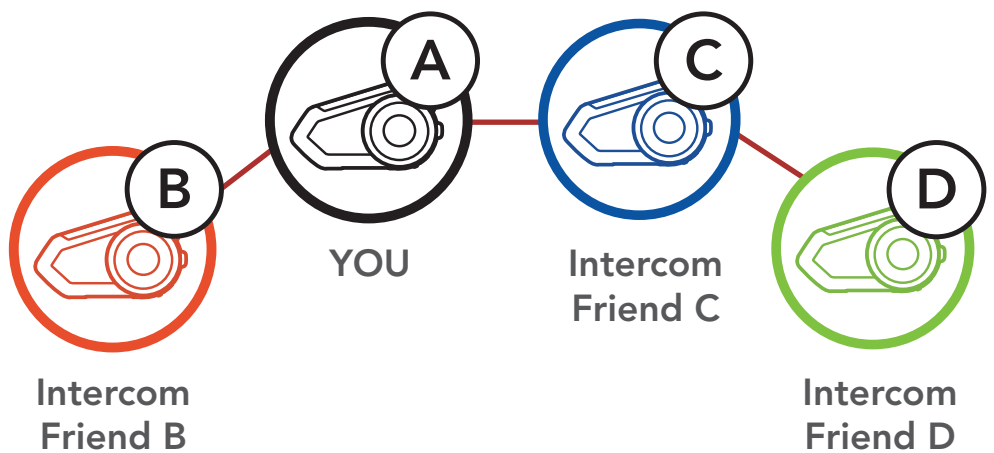

Intercom
Pairing

Two-Way
Intercom

Multi-Way
Intercom

Three-Way
Conference
Phone Call
with Intercom
Users

Group
Intercom

Universal
Intercom

VOX Intercom

Intercom VOX
Sensitivity

HD Intercom

Advanced
Noise
Control™



7. BLUETOOTH INTERCOM SETUP

7.3.3 Ending Multi-Way Intercom

1. Press the **Jog Dial** for **1 second** until you hear a beep to terminate all intercom connections.
2. Tap the **Jog Dial** to disconnect from your first **Intercom Friend**. Double tap the **Jog Dial** to disconnect from your second **Intercom Friend**.

7.4 Three-Way Conference Phone Call with Intercom Users

You can have a **Three-Way Conference Phone Call** by adding an **Intercom Friend** to the mobile phone conversation.

1. During a mobile phone call, tap the **Jog Dial** **once, twice or, three times** to invite one of your **Intercom Friends** to the conversation.

Invite an Intercom Friend into Phone Conference

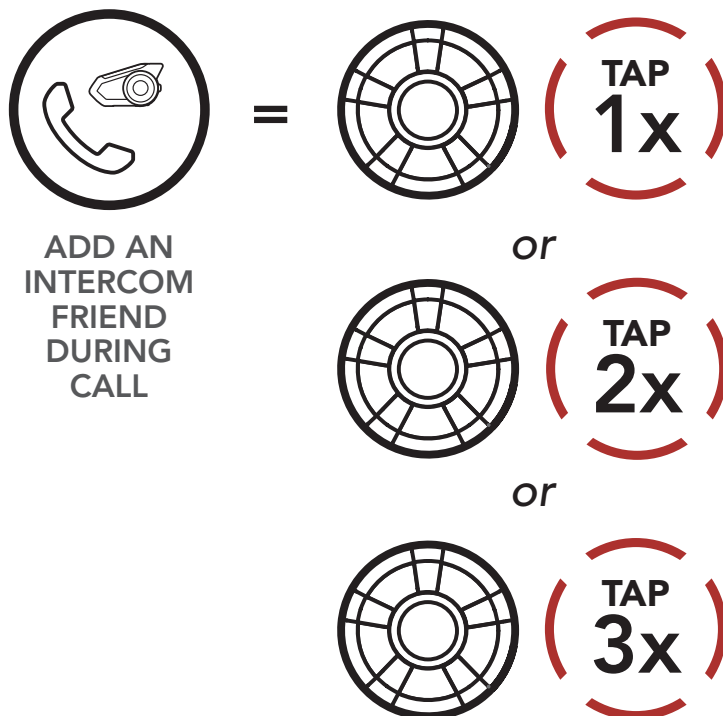

Intercom Pairing

Two-Way Intercom

Multi-Way Intercom

Three-Way Conference Phone Call with Intercom Users

Group Intercom

Universal Intercom

VOX Intercom

Intercom VOX Sensitivity

HD Intercom

Advanced Noise Control™



7. BLUETOOTH INTERCOM SETUP

2. To disconnect the intercom during a conference phone call, tap the **Jog Dial once, twice or three times.**

Disconnect Intercom Friend from Conference

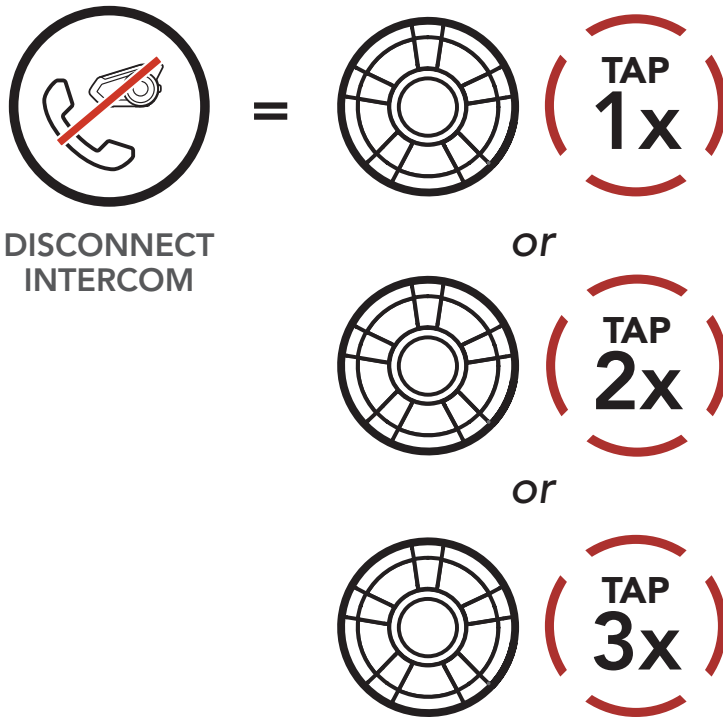

- Intercom Pairing
- Two-Way Intercom
- Multi-Way Intercom
- Three-Way Conference Phone Call with Intercom Users
- Group Intercom
- Universal Intercom
- VOX Intercom
- Intercom VOX Sensitivity
- HD Intercom
- Advanced Noise Control™

3. To disconnect the mobile phone call during a conference phone call, tap the **Phone Button.**

End Phone Call from Conference

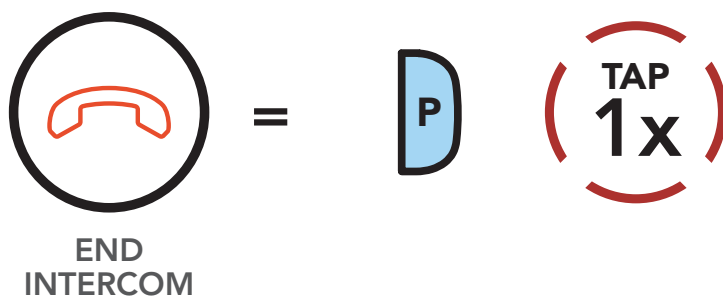

Note: When you have an incoming intercom call during a mobile phone call, you will hear a voice prompt, "Intercom requested."



7. BLUETOOTH INTERCOM SETUP

7.5 Group Intercom

Group Intercom allows you to instantly create a **Multi-Way Conference Intercom** with three of the most recently paired headsets.

1. Go through intercom pairing with up to three headsets you want to have **Group Intercom** with.
2. Press the **Ambient Mode Button** for **1 second** to begin **Group Intercom**. The LED will flash green and you will hear a voice prompt, "**Group intercom**".

Start Group Intercom

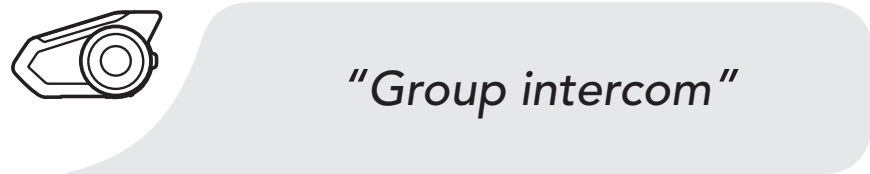
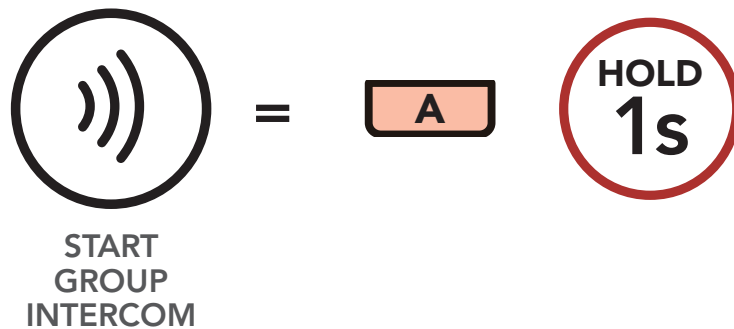

3. When all of the headsets are connected together, everyone will hear the voice prompt, "**Group intercom connected.**"

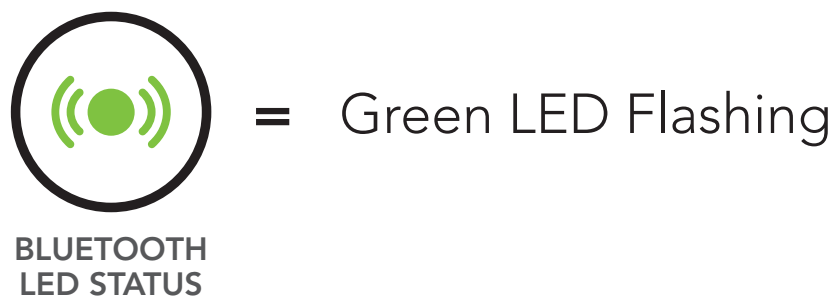

- Intercom Pairing
- Two-Way Intercom
- Multi-Way Intercom
- Three-Way Conference Phone Call with Intercom Users
- Group Intercom
- Universal Intercom
- VOX Intercom
- Intercom VOX Sensitivity
- HD Intercom
- Advanced Noise Control™



7. BLUETOOTH INTERCOM SETUP

- To terminate **Group Intercom**, press the **Ambient Mode Button** for **1 second** during **Group Intercom**. You will hear a voice prompt, "**Group intercom terminated**".

End Group Intercom

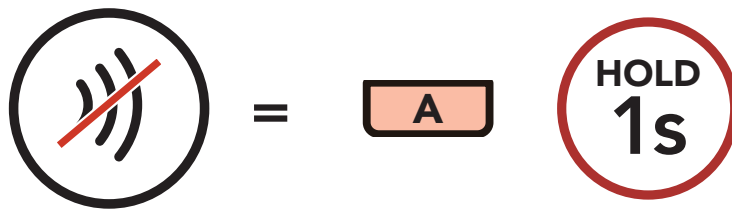

END GROUP INTERCOM

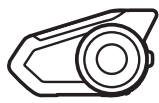

"Group intercom terminated"

Intercom Pairing

Two-Way Intercom

Multi-Way Intercom

Three-Way Conference Phone Call with Intercom Users

Group Intercom

Universal Intercom

VOX Intercom

Intercom VOX Sensitivity

HD Intercom

Advanced Noise Control™

7.6 Universal Intercom

Universal Intercom allows you to have intercom conversations with users of non-Sena Bluetooth headsets. You can pair your headset with only one non-Sena headset at a time. The intercom distance depends on the performance of the Bluetooth headset to which it's connected. When a non-Sena Bluetooth headset is paired with the Sena headset, if another Bluetooth device is paired via **Second Mobile Phone Pairing**, it will be disconnected.

- Execute **Universal Intercom** in the **Headset Configuration Menu**.



7. BLUETOOTH INTERCOM SETUP

Access Universal Intercom in the Configuration Menu

Intercom Pairing

Two-Way Intercom

Multi-Way Intercom

Three-Way Conference Phone Call with Intercom Users

Group Intercom

Universal Intercom

VOX Intercom

Intercom VOX Sensitivity

HD Intercom

Advanced Noise Control™

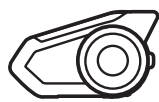
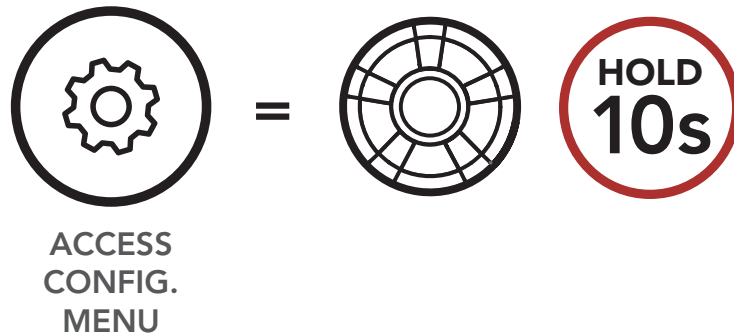

"Configuration menu"

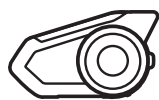
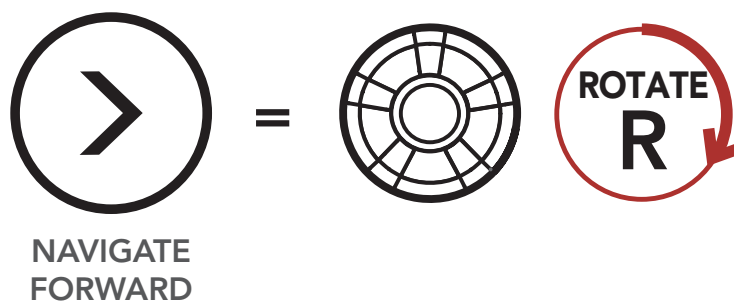

"Universal intercom"

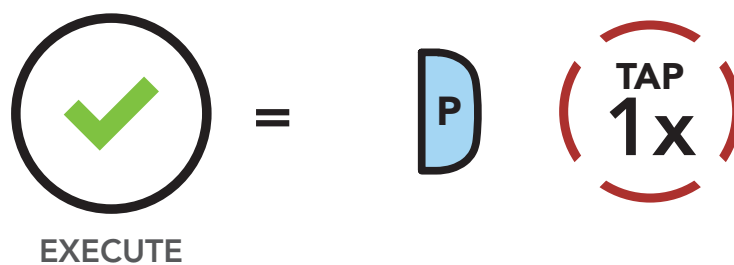

- Put the non-Sena Bluetooth headset in Pairing Mode. The headset will automatically pair with a non-Sena Bluetooth headset.



7. BLUETOOTH INTERCOM SETUP

3. You can have **Two-Way Intercom** or **Multi-Way Intercom** communication with up to three **Intercom Friends** using non-Sena headsets by following the procedures described below.

Example of a Three-Way Universal Intercom

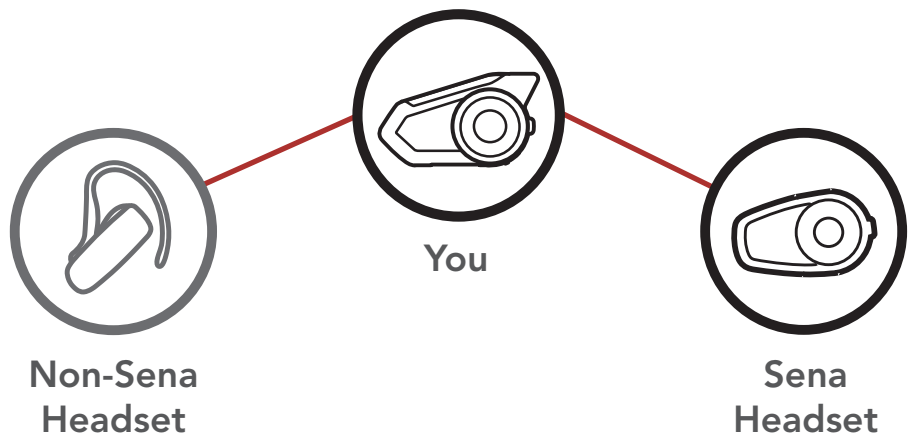

Example of a Four-Way Universal Intercom

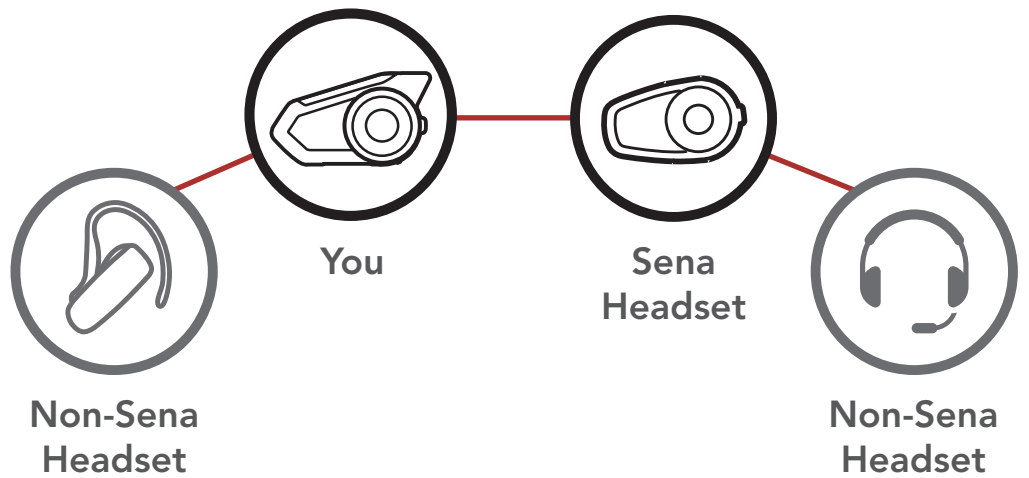

Intercom Pairing

Two-Way Intercom

Multi-Way Intercom

Three-Way Conference Phone Call with Intercom Users

Group Intercom

Universal Intercom

VOX Intercom

Intercom VOX Sensitivity

HD Intercom

Advanced Noise Control™



7. BLUETOOTH INTERCOM SETUP

7.7 VOX Intercom (Default: Disable)

Intercom
Pairing

Two-Way
Intercom

Multi-Way
Intercom

Three-Way
Conference
Phone Call
with Intercom
Users

Group
Intercom

Universal
Intercom

VOX Intercom

Intercom VOX
Sensitivity

HD Intercom

Advanced
Noise
Control™

The **VOX Intercom** setting can be found in the settings menu, accessible through **Sena Device Manager** or **Sena Smartphone App**.

If **VOX Intercom** is enabled, you can initiate an intercom conversation with the last connected intercom friend by voice. When you want to start intercom, say a word such as **"Hello"** loudly or blow air into the microphone. If you start an intercom conversation by voice, the intercom terminates automatically when you and your intercom friend remain silent for 20 seconds. However, if you manually start an intercom conversation by tapping the **Jog Dial**, you have to terminate the intercom conversation manually.

However, if you start the intercom by voice and end it manually by tapping the **Jog Dial**, you will not be able to start intercom by voice temporarily. In this case, you have to tap the **Jog Dial** to restart the intercom. This is to prevent repeated unintentional intercom connections by strong wind noise. After rebooting the headset, you can start the intercom by voice again.



7. BLUETOOTH INTERCOM SETUP

7.8 Intercom VOX Sensitivity (Default: 3)

The **Intercom VOX Sensitivity** setting can be found in the settings menu, accessible through **Sena Device Manager** or **Sena Smartphone App**.

The sensitivity can be adjusted depending on your riding environment. Level 5 is the highest sensitivity setting and 1 is the lowest.

7.9 HD Intercom (Default: Enable)

The **HD Intercom** setting can be found in the settings menu, accessible through **Sena Device Manager** or **Sena Smartphone App**.

HD Intercom enhances the two-way intercom audio from normal quality to HD quality. **HD Intercom** will become temporarily disabled when you enter into a multi-way intercom. If this feature is disabled, the two-way intercom audio will change to normal quality.

Note: The intercom distance of **HD Intercom** is relatively shorter than that of normal intercom.

7.10 Advanced Noise Control™ (Default: Enable)

The **Advanced Noise Control** setting can be found in the settings menu, accessible through **Sena Device Manager** or **Sena Smartphone App**.

If **Advanced Noise Control** is enabled, background noise is reduced during intercom conversations.

If **Advanced Noise Control** is disabled, the background noise is mixed with your voice while using the intercom.

Intercom
Pairing

Two-Way
Intercom

Multi-Way
Intercom

Three-Way
Conference
Phone Call
with Intercom
Users

Group
Intercom

Universal
Intercom

VOX Intercom

Intercom VOX
Sensitivity

HD Intercom

Advanced
Noise
Control™



8. MESH INTERCOM

8.1 What is Mesh Intercom?

What is Mesh Intercom?

Mesh Intercom Mode

Using the Mesh

Mesh Intercom Conference with Bluetooth Intercom Participant

Mesh Intercom is an adaptive and autonomous intercom technology developed by Sena which features self-organizing, self-healing, self-optimizing, and multi-hopping group communication. **Mesh Intercom** allows riders to connect and communicate with nearby users without the need to pair each headset together.

Starting Mesh Intercom

When **Mesh Intercom** is enabled, the headset will automatically connect to nearby 30K users and allow them to talk to each other by pressing the **Mesh Intercom Button**.

Mesh Intercom On

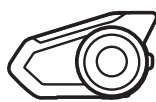
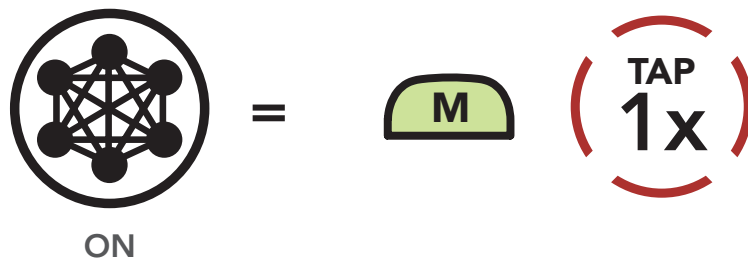

"Mesh intercom on"

Mesh Intercom Off

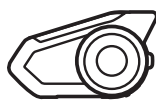
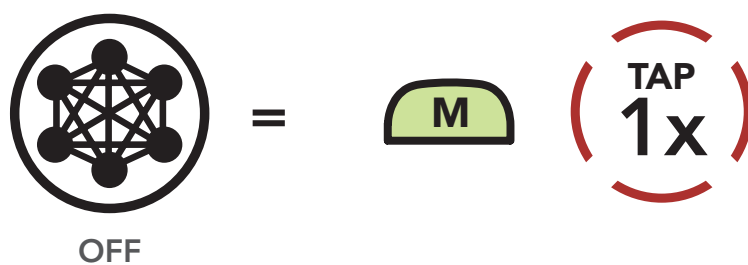

"Mesh intercom off"

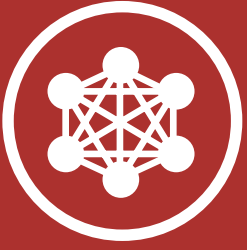

8. MESH INTERCOM

8.2 Mesh Intercom Mode (Default: Public Mode)

8.2.1 Public Mode

When **Mesh Intercom** is enabled, the headset will be in **Public Mode** initially. It can connect with a virtually unlimited number of nearby 30K headsets within a 1.6 km (1.0 mile) range. Within this group, 6 users can talk at the same time for an optimized, open group intercom conversation. Users can freely connect with each other when in **Public Mode**. The audio quality of the intercom conversation will be the best when communicating using **Public Mode**. The headset will not save the connection information from any of the headsets that it is connected to for future open group intercom conversations when in **Public Mode**.

Mesh Intercom in Public Mode

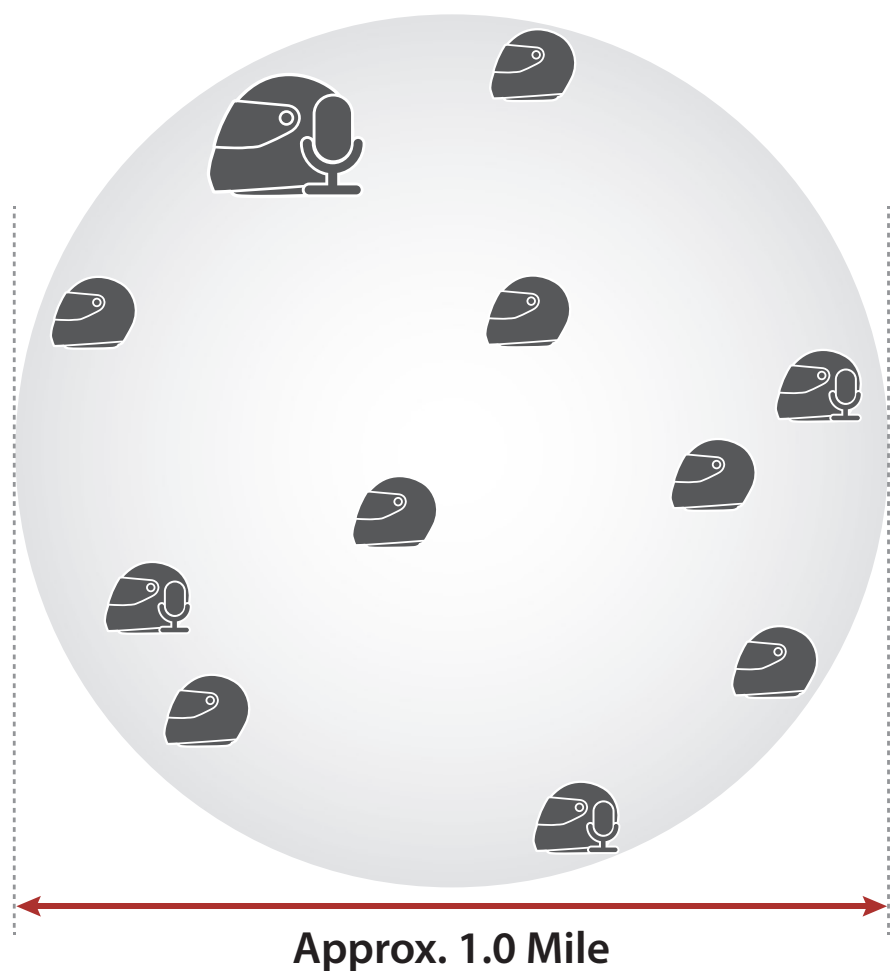

- Limitless participants within range
- 6 people talk at the same time

What is Mesh Intercom?

Mesh Intercom Mode

Using the Mesh

Mesh Intercom Conference with Bluetooth Intercom Participant

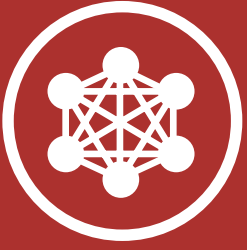

8. MESH INTERCOM

8.2.2 Private Mode

What is Mesh Intercom?

Mesh Intercom Mode

Using the Mesh

Mesh Intercom Conference with Bluetooth Intercom Participant

Mesh

A Mesh is a closed network of headsets where participants can leave, join or rejoin a group intercom conversation without affecting the connection between each of the headsets. For a closed intercom conversation using **Mesh Intercom**, a Mesh needs to be created by a user. When a user creates a Mesh, the headset automatically switches from **Public Mode** to **Private Mode**.

Mesh Intercom in Private Mode

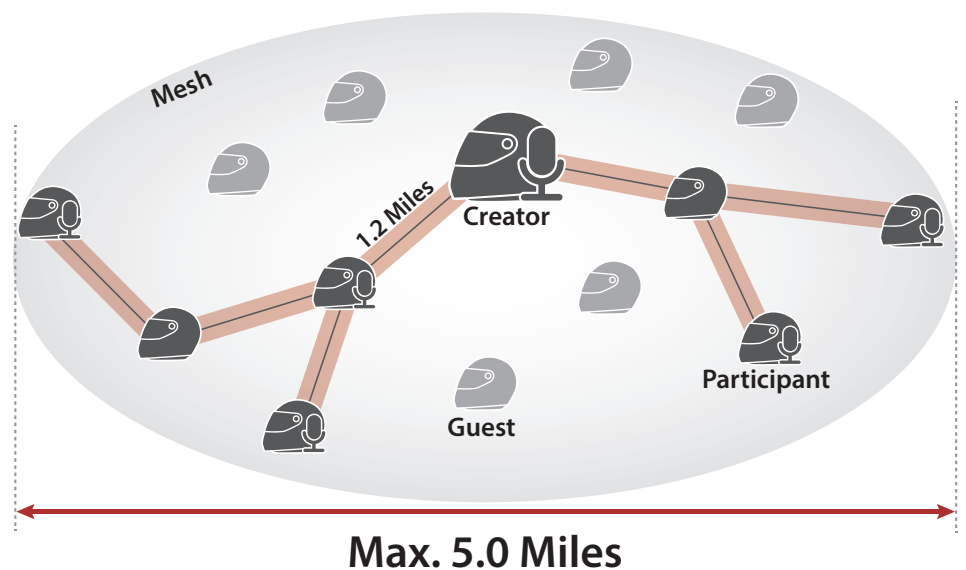

- Max. participants : 15 participants + 1 creator
- 6 people talk at the same time
- Limitless guests only listen within "Mesh" range



8. MESH INTERCOM

What is Mesh Intercom?

Mesh Intercom Mode

Using the Mesh

Mesh Intercom Conference with Bluetooth Intercom Participant

Private Mode

When the headset is in **Private Mode**, it can connect with up to 15 other 30K headsets. The range between each headset in Private Mode can be up to 2.0 km (1.2 miles). The Mesh can extend up to 8.0 km (5.0 miles) head-to-tail during a closed intercom conversation. Within this group, 6 users can talk at the same time for an optimized closed group conversation. The audio quality when communicating in a Mesh automatically adjusts according to the number of participants. When connected together in a Mesh, the headset will automatically save the connection information from all of the other headsets that it has connected to for future **Mesh Intercom** group communication.

8.2.3 Guest Mode (Default: Disable)

A **Guest Mode** setting can be found in the settings menu, accessible through **Sena Device Manager** or **Sena Smartphone App**. **Guest Mode** allows a guest to listen to a closed Mesh conversation. The creator of the Mesh needs to enable **Guest Mode** before creating the Mesh to allow guests. **Guest Mode** can be enabled when the guest is in **Public Mode** and the **Mesh Network** connection information has been removed. The guest needs to be within range of the Mesh to listen to the closed Mesh conversation.

Note: When the creator enables **Guest Mode**, a virtually unlimited number of guests can connect to a Mesh.



8. MESH INTERCOM

8.3 Using the Mesh

What is Mesh Intercom?

Mesh Intercom Mode

Using the Mesh

Mesh Intercom Conference with Bluetooth Intercom Participant

8.3.1 Creating the Mesh

A user can create a Mesh so that they can invite nearby 30K headsets to join in a closed intercom conversation.

Create Mesh [Creator]

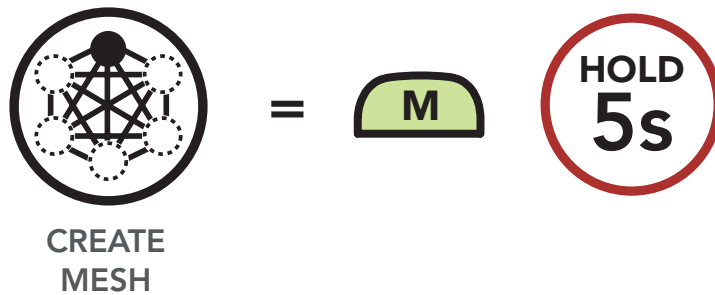

=

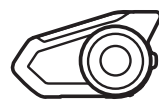

"Creating mesh"

Users within range and in **Public Mode** can accept the invitation sent by the creator of the Mesh to join a closed intercom conversation after hearing the voice prompt **"Would you like to join a mesh?"**

Accept Invitation During Mesh Creation [Participant]

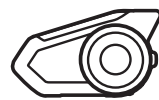

"Would like to join a mesh?"



=



"Joined the mesh"



8. MESH INTERCOM

What is Mesh Intercom?

Mesh Intercom Mode

Using the Mesh

Mesh Intercom Conference with Bluetooth Intercom Participant

Note: A user can join the Mesh within **30 seconds** after hearing the invitation voice prompt.

8.3.2 Join an Existing Mesh

Users that did not accept the invitation from the creator or were not invited can request to join the Mesh.

Join an Existing Mesh [Participant]

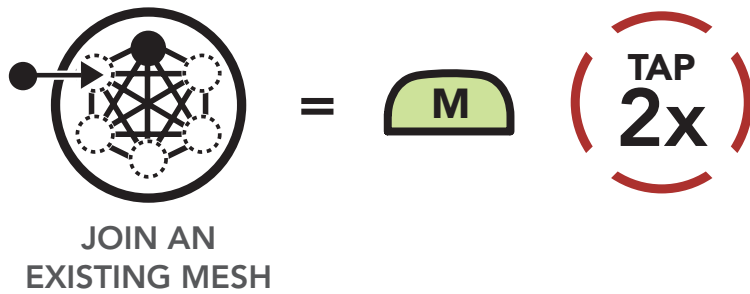

"Searching for Mesh"

[Creator]



"Would you like to add a new participant?"

The creator of the Mesh can accept the request for a user to join the closed intercom.

Accept a participant [Creator]

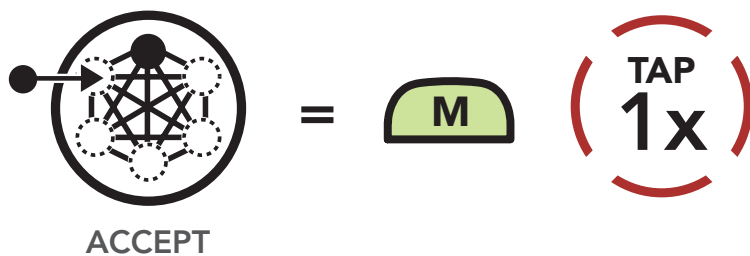

[Participant]



"Joined the mesh"



8. MESH INTERCOM

What is Mesh Intercom?

Mesh Intercom Mode

Using the Mesh

Mesh Intercom Conference with Bluetooth Intercom Participant

The creator of the Mesh can reject the request for a user to join the closed intercom.

Reject a participant [Creator]

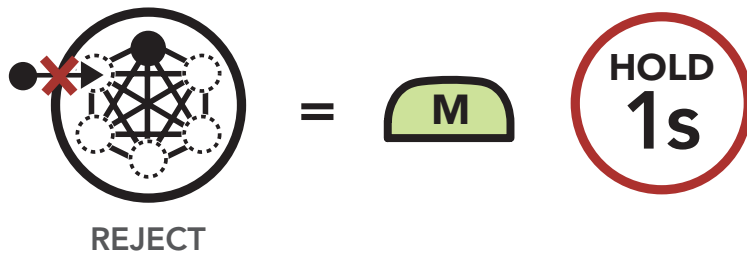

[Participant]

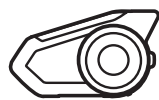

"Request rejected"

8.3.3 Quit the Mesh

Users that quit the Mesh will automatically return to **Public Mode**.

Quit the Mesh

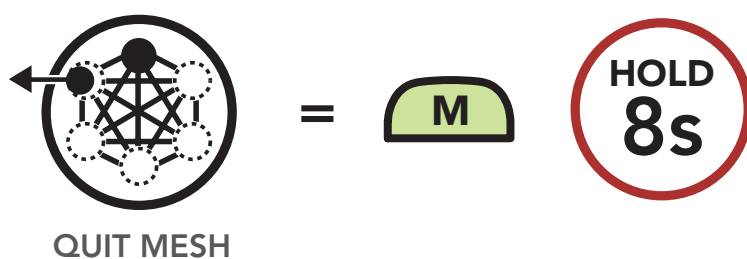

"Quit the mesh"

Note: When a user quits the Mesh, the headset will automatically switch to **Public Mode** and the stored **Mesh Network** information will be deleted.



8. MESH INTERCOM

8.3.4 Toggle Public Mode / Private Mode

A user is able to toggle between **Public Mode** and **Private Mode** without quitting the Mesh. This allows the user to keep the **Mesh Network** connection information while in **Public Mode**. The user can toggle to **Private Mode** to communicate with participants from the stored **Mesh Network** information.

Toggle Between Public Mode and Private Mode

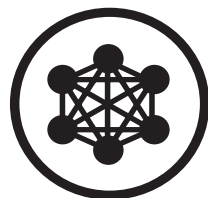

PRIVATE
MODE

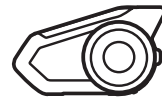

"Private Mode"



=



PUBLIC
MODE

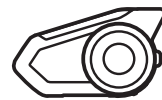

"Public Mode"

What is Mesh Intercom?

Mesh Intercom Mode

Using the Mesh

Mesh Intercom Conference with Bluetooth Intercom Participant



8. MESH INTERCOM

8.3.5 Toggle Public Mode / Guest Mode

Toggle Between Public Mode and Guest Mode



GUEST
MODE

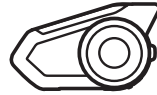

"Guest Mode"



=



PUBLIC
MODE

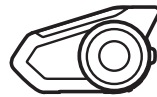

"Public Mode"

What is Mesh Intercom?

Mesh Intercom Mode

Using the Mesh

Mesh Intercom Conference with Bluetooth Intercom Participant

8.3.6 Mic Enable/Disable (Default: Enable)

Users can enable/disable the microphone when communicating in a **Mesh Intercom**. This can be done in either **Public Mode** or **Private Mode**.

Enable / Disable the Microphone



ENABLE /
DISABLE THE
MICROPHONE

=



"Mic on / Mic off"



8. MESH INTERCOM

8.4 Mesh Intercom Conference with Bluetooth Intercom Participant

Users can use the existing Bluetooth intercom and **Mesh Intercom** function at the same time. In this case, it is recommended to communicate with other Sena headsets via Bluetooth intercom connection and use **Mesh Intercom** between 30K headsets. Please refer to **Section 7: "Bluetooth Intercom Setup"** for more details.

Note: If a closed loop is created, as shown below, each user will experience severe noise issues. Sena recommends that a closed loop not be created.

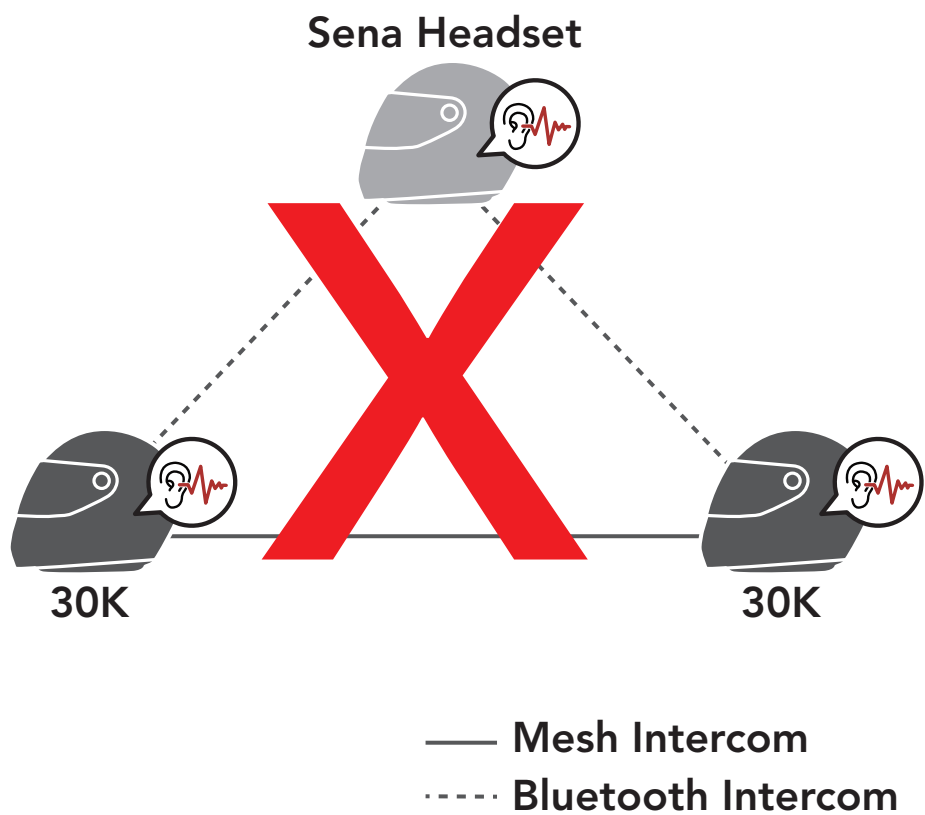

What is Mesh Intercom?

Mesh Intercom Mode

Using the Mesh

Mesh Intercom Conference with Bluetooth Intercom Participant



Audio Multitasking Settings

Intercom-Audio Overlay Sensitivity

Audio Overlay Volume Management

9. AUDIO MULTITASKING

Audio Multitasking allows you to have an intercom conversation while simultaneously listening to music, FM radio, or GPS instructions. The overlaid audio is played in the background with reduced volume whenever there is an intercom conversation and will return to normal volume once the conversation is finished. The Audio Multitasking feature can be configured through the **Intercom-Audio Overlay Sensitivity** and the **Audio Overlay Volume Management** settings.

9.1 Audio Multitasking Settings

The Mesh Intercom Audio Multitasking feature is always on. The **Bluetooth Intercom Audio Multitasking (Default: Disabled)** setting can be found in the settings menu, accessible through the **Sena Device Manager** or the **Sena Smartphone App**.

Note:

1. **Bluetooth Intercom Audio Multitasking** will be activated during two-way intercom conversations with a headset that also supports this feature.
2. HD Intercom will become disabled temporarily when **Bluetooth Intercom Audio Multitasking** is enabled.
3. For **Bluetooth Intercom Audio Multitasking** to work properly, you need to power the headset off and on. Please restart the headset.
4. Some GPS devices may not support this feature.
5. **Bluetooth Intercom Audio Multitasking** has limited usage for iOS devices.



Audio
Multitasking
Settings

Intercom-
Audio Overlay
Sensitivity

Audio Overlay
Volume
Management

9. AUDIO MULTITASKING

9.2 Intercom-Audio Overlay Sensitivity (Default: 3)

The **Intercom-Audio Overlay Sensitivity** setting can be found in the settings menu, accessible through **Sena Device Manager** or **Sena Smartphone App**. The music, FM radio and GPS volume will be lowered to play in the background if you talk over the intercom while the overlaid audio is playing. You can adjust the intercom sensitivity to activate this background audio mode. Level 1 has the lowest sensitivity and level 5 has the highest sensitivity.

Note: If your voice is not louder than the sensitivity of the selected level, the overlaid audio will not be lowered.

9.3 Audio Overlay Volume Management (Default: Disable)

The **Audio Overlay Volume Management** setting can be found in the settings menu, accessible through **Sena Device Manager** or **Sena Smartphone App**. The music, FM radio and GPS overlaid audio reduces in volume whenever there is an ongoing intercom conversation. If **Audio Overlay Volume Management** is enabled, the volume level of the overlaid audio will not be reduced during intercom conversation.



10. USING THE FM RADIO

10.1 FM Radio On/Off

To turn on or shut off the FM radio, press the **Phone Button** for **1 second** until you hear a double beep.

FM Radio On

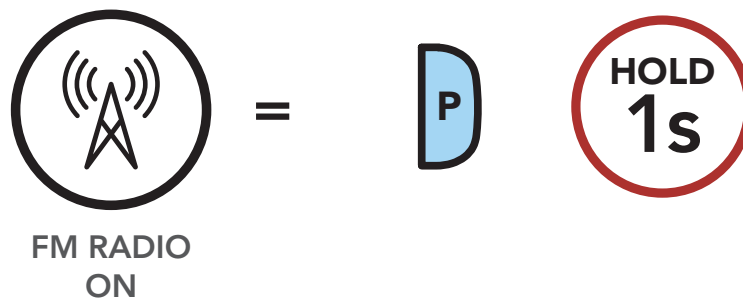

FM RADIO ON

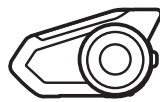

"FM on"

FM Radio Off

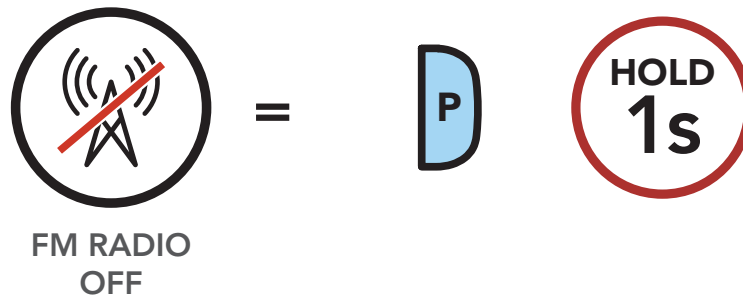

FM RADIO OFF



"FM off"

FM Radio On/Off

Seek and Save Radio Stations

Scan and Save Radio Stations

Temporary Station Preset

Navigating Preset Stations

Region Selection

Radio Data System (RDS) Alternative Frequency (AF) Setting

FM Station Guide



10. USING THE FM RADIO

10.2 Seek and Save Radio Stations

The "Seek" feature searches for radio stations.

1. Rotate while pressing the **Jog Dial** clockwise or counterclockwise to search for radio stations.

Seek Stations Forward

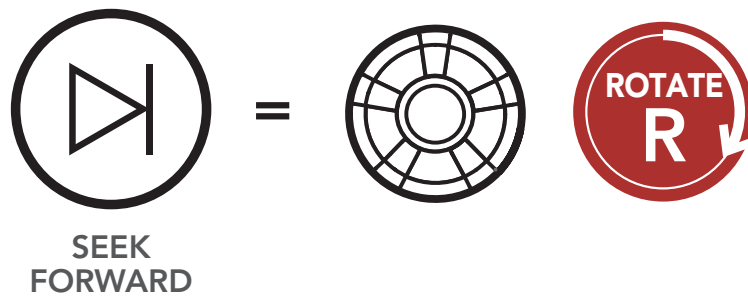

Seek Stations Backward

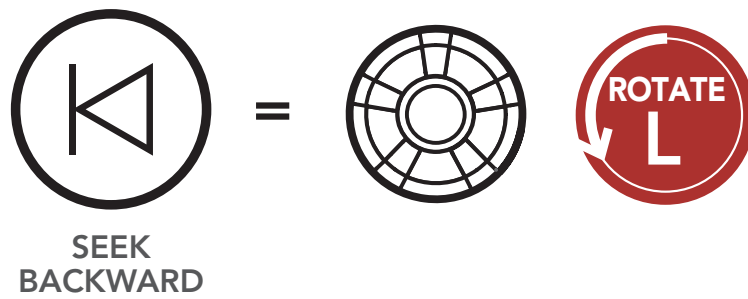

2. To save the current station, press and hold the **Jog Dial** for **1 seconds** until you hear the voice prompt, "Preset (#)."

Enter Preset Selection Mode

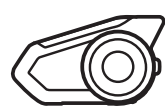
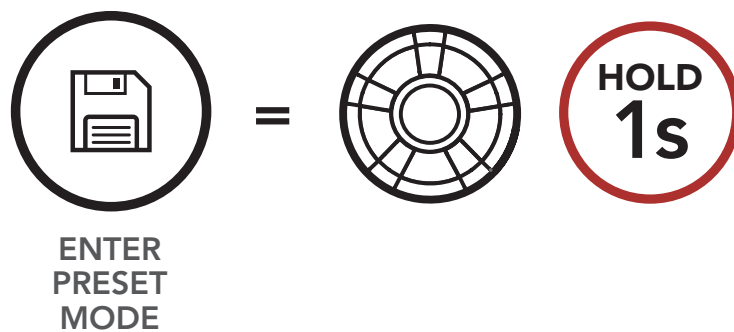

"Preset (#)"

FM Radio On/Off

Seek and Save Radio Stations

Scan and Save Radio Stations

Temporary Station Preset

Navigating Preset Stations

Region Selection

Radio Data System (RDS) Alternative Frequency (AF) Setting

FM Station Guide



10. USING THE FM RADIO

3. Rotate the **Jog Dial** to navigate through the preset numbers that you want to store.

FM Radio On/Off

Seek and Save Radio Stations

Scan and Save Radio Stations

Temporary Station Preset

Navigating Preset Stations

Region Selection

Radio Data System (RDS) Alternative Frequency (AF) Setting

FM Station Guide

Navigate Forward through Preset Stations

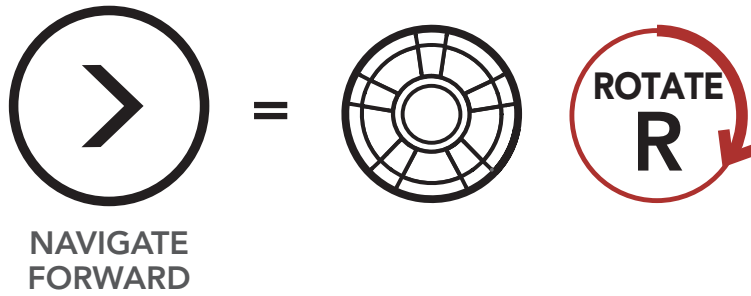

Navigate Backward through Preset Stations

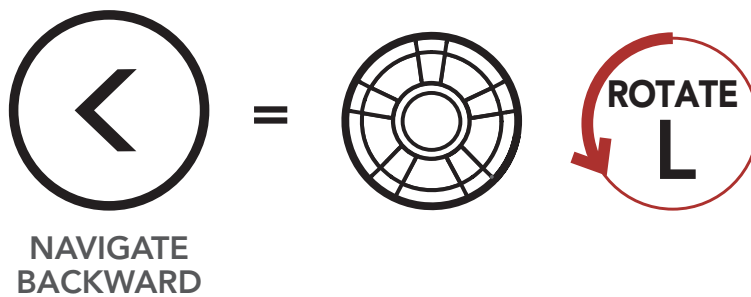

4. Tap the **Jog Dial** to save the station in the preset number you choose. Or, tap the **Phone Button** to delete the station from memory.

Save Station to the Preset Number

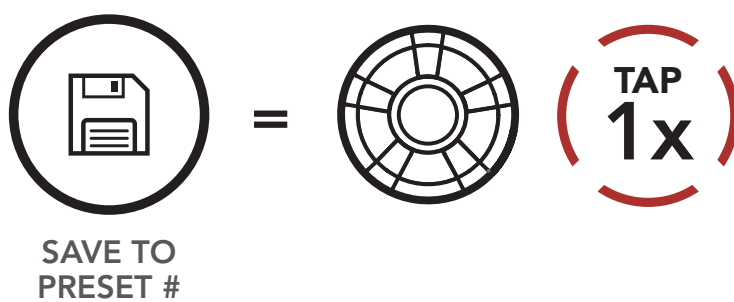

Delete Station from Memory

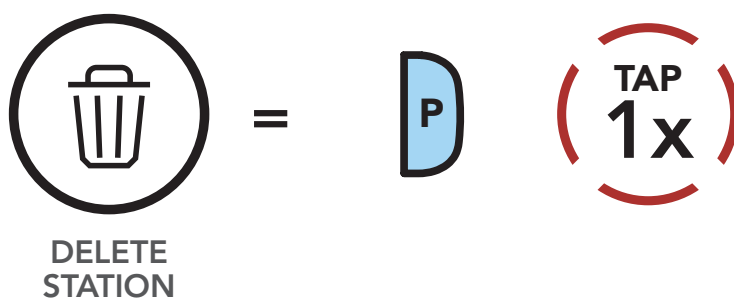



10. USING THE FM RADIO

10.3 Scan and Save Radio Stations

The **“Scan”** function automatically searches for radio stations, starting with the current station’s frequency, then up from there.

1. Double tap the **Phone Button** to scan for stations.

Scan and Save Radio Stations

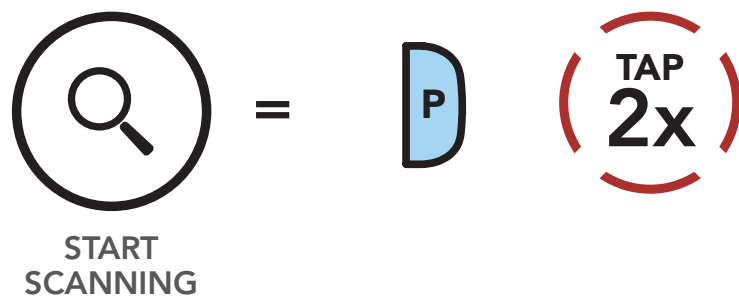

2. The Sena tuner pauses at each station it finds for **8 seconds** before moving to the next.
3. To save the current station, tap the **Phone Button**. The station will be saved as the next preset number.

Save the Current Station

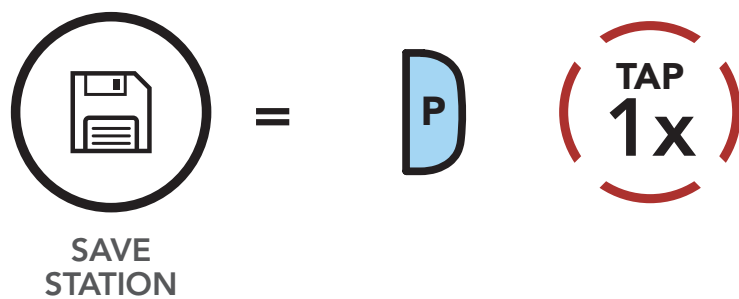

“Save preset (#)”

FM Radio On/Off

Seek and Save Radio Stations

Scan and Save Radio Stations

Temporary Station Preset

Navigating Preset Stations

Region Selection

Radio Data System (RDS) Alternative Frequency (AF) Setting

FM Station Guide



10. USING THE FM RADIO

4. To stop scanning, double tap the **Phone Button**.

Stop Scanning

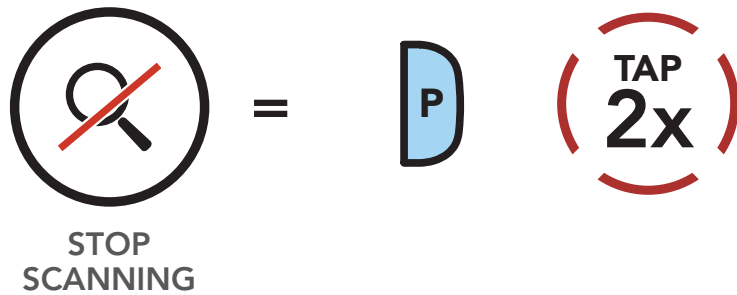

10.4 Temporary Station Preset

The **Temporary Preset** feature automatically finds and saves the nearest 10 radio stations without changing your existing preset stations.

1. Tap the **Phone Button** three times to automatically find and save 10 stations.

Temporary Stations

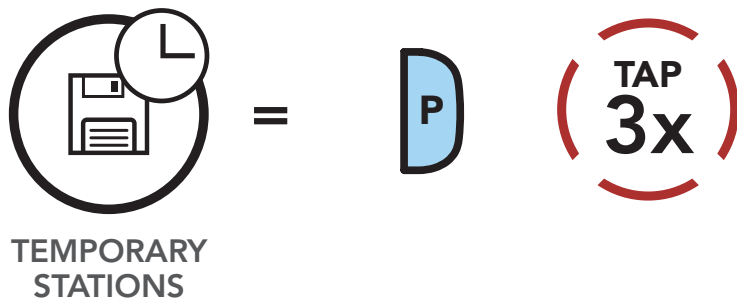

2. The temporary preset stations will be cleared when the headset reboots.

FM Radio On/Off

Seek and Save Radio Stations

Scan and Save Radio Stations

Temporary Station Preset

Navigating Preset Stations

Region Selection

Radio Data System (RDS) Alternative Frequency (AF) Setting

FM Station Guide



10. USING THE FM RADIO

10.5 Navigating Preset Stations

Using the methods above, up to 10 radio stations can be stored. Tap the **Phone Button** to navigate through the saved stations.

Navigate through Preset Stations

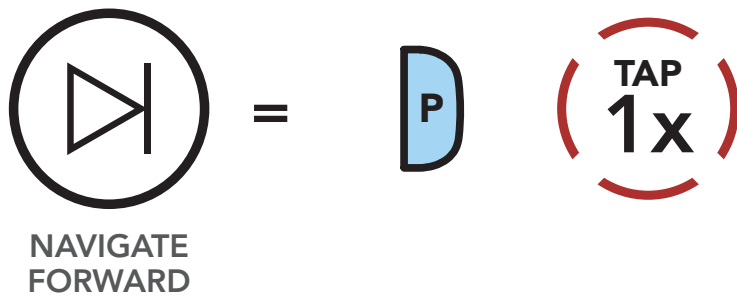

Note: You can use the **Sena Device Manager** or the **Sena Smartphone App** to save the preset stations.

10.6 Region Selection (Default: Worldwide)

You can select the proper FM frequency range for your location from the **Sena Device Manager** or the **Sena Smartphone App**. Using the region setting, you can optimize the seek function to avoid unnecessary frequency ranges.

Region	Frequency range	Step
Worldwide	76.0 ~ 108.0 MHz	± 100 kHz
North America, South America and Australia	87.5 ~ 107.9 MHz	± 200 kHz
Asia and Europe	87.5 ~ 108.0 MHz	± 100 kHz
Japan	76.0 ~ 95.0 MHz	± 100 kHz

FM Radio On/Off

Seek and Save Radio Stations

Scan and Save Radio Stations

Temporary Station Preset

Navigating Preset Stations

Region Selection

Radio Data System (RDS) Alternative Frequency (AF) Setting

FM Station Guide



10. USING THE FM RADIO

10.7 Radio Data System (RDS)

Alternative Frequency (AF) Setting (Default: Disable)

FM Radio
On/Off

Seek and
Save Radio
Stations

Scan and
Save Radio
Stations

Temporary
Station Preset

Navigating
Preset
Stations

Region
Selection

Radio Data
System (RDS)
Alternative
Frequency
(AF) Setting

FM Station
Guide

The **RDS AF** setting can be found in the settings menu, accessible through **Sena Device Manager** or **Sena Smartphone App**.

When radio station signals get too weak for a good reception, with **RDS AF** enabled, the Sena radio receiver re-tunes to a station with better reception. If **RDS AF** is disabled, you'll have to find stronger stations manually.

10.8 FM Station Guide (Default: Enable)

The **Station Guide** setting can be found in the settings menu, accessible through **Sena Device Manager** or **Sena Smartphone App**.

When **FM Station Guide** is enabled, FM station frequencies are given by voice prompts as you select preset stations. When **FM Station Guide** is disabled, the voice prompts on FM station frequencies will not be given as you select preset stations.



11. AMBIENT MODE

You can hear the ambient sound outside of your helmet by activating the **Ambient Mode**. To activate the **Ambient Mode**, press the **Ambient Mode Button** twice which is placed on the bottom of the clamp unit. To deactivate the **Ambient Mode**, press the **Ambient Mode Button** twice again.

Ambient Mode

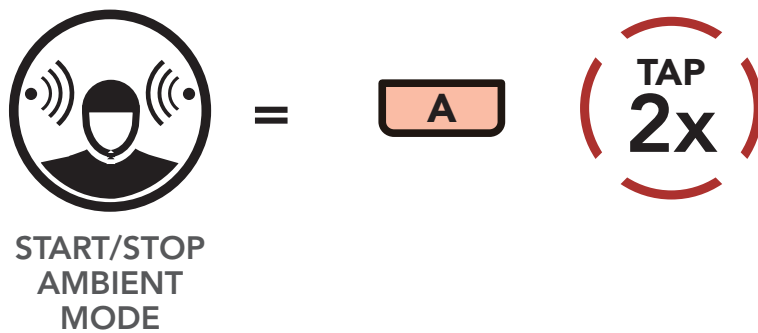

Note: The **Ambient Mode** has higher priority than mobile phone, so you cannot listen to music, or have an intercom conversation if the **Ambient Mode** is activated.



Voice Command Setting

12. VOICE COMMAND

The voice command of the headset allows you to operate certain operations by simply using your voice. You can control the headset completely handsfree using the voice recognition. The voice command function works only with English commands.

Voice Command

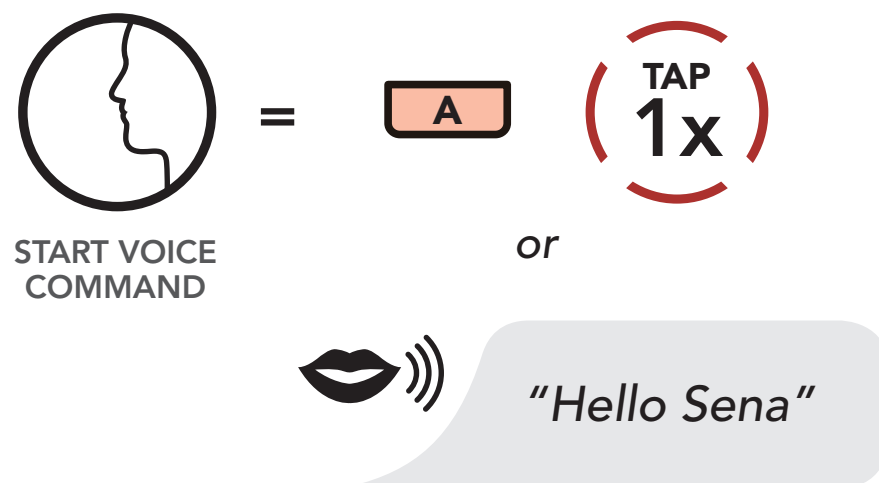

Speak a voice command from the table below:

Mode Status	Function	Voice Command
Standby / Intercom	Start/End each Intercom	“Intercom [one, two, three]”
	End all intercoms	“End intercom”
	Call last intercom	“Last intercom”
	Group intercom	“Group intercom”
	Intercom pairing	“Pairing intercom”
	Cancelling operations	“Cancel”



12. VOICE COMMAND

Voice Command Setting

Mode Status	Function	Voice Command
Standby / Music / FM Radio	Play/Pause music	"Music" or "Stereo"
	Turn on/off FM radio	"FM radio"
	Check battery	"Check battery"
	Speed dialing	"Speed dial [one, two, three]"
	Redial the last call	"Redial"
	Voice command help	"What can I say?"
	Check connected devices	"Connected devices"
	Configuration menus	"Configuration"
Music / FM Radio	Next track (music) / next preset (FM radio)	"Next"
	Previous track (music) / previous preset (FM radio)	"Previous"
	Stop music / FM radio	"Stop"
Standby / Mesh Intercom	Mesh intercom On/Off	"Mesh intercom"
	End the Bluetooth and Mesh intercom	"End intercom"
	Create a Mesh	"Create Mesh"
	Quit the Mesh	"Quit Mesh"



Voice Command Setting

12. VOICE COMMAND

Note:

- Voice command performance may vary based on the environmental conditions including riding speed, helmet type and ambient noise. To improve the performance, minimize wind noise on the microphone by using a large microphone sponge and closing the visor.
- To activate the voice command during intercom conversation, tap the **Ambient Mode Button** once.

12.1 Voice Command Setting (Default: Enable)

A **Voice Command** setting can be found in the settings menu, accessible through **Sena Device Manager** or **Sena Smartphone App**.

When **Voice Command** is enabled, you can use your voice to give a command the headset operate certain operations completely handsfree. If **Voice Command** is disabled, you will need to operate all of the functions using the buttons on the headset.



13. GENERAL SETTINGS

13.1 Function Priority

The headset prioritizes connected devices in the following order:

Function Priority

Firmware Upgrades

Voice Prompts

Sidetone

Delete All Bluetooth Pairing Information

(highest)

Ambient Mode

Mobile phone

Voice command mode

Mesh Intercom / Bluetooth Intercom

Music sharing via Bluetooth stereo

FM radio

Stereo music by audio cable

(lowest)

Bluetooth stereo music

A lower-priority function gets interrupted by a higher-priority function. For example, stereo music will be interrupted by an **Intercom Conversation**; an **Intercom Conversation** will be interrupted by an incoming mobile phone call.

13.2 Firmware Upgrades

The headset supports firmware upgrades. You can upgrade the firmware using the **Sena Device Manager**. Please visit sena.com to check for the latest software downloads.

[Click Here to Visit sena.com](http://sena.com)



13. GENERAL SETTINGS

13.3 Voice Prompts (Default: Enable)

Function
Priority

Firmware
Upgrades

Voice
Prompts

Sidetone

Delete All
Bluetooth
Pairing
Information

A **Voice prompt** setting can be found in the settings menu, accessible through **Sena Device Manager** or **Sena Smartphone App**.

If **Voice prompt** is enabled, you can hear **Voice prompts** for different kinds of features. If **Voice prompt** is disabled, **Voice prompts** are silenced except for those in the Configuration Menu, battery level indication, speed dial, and FM radio functions.

13.4 Sidetone (Default: Disable)

A **Sidetone** setting can be found in the settings menu, accessible through **Sena Device Manager** or **Sena Smartphone App**.

Sidetone is the sound of your own voice as picked up by your headset's microphone and reproduced in your own ear, by your own speaker. It helps you to naturally speak at the correct level according to varying helmet noise conditions. If this feature is enabled, you can hear what you are speaking during an intercom conversation or a phone call.



13. GENERAL SETTINGS

13.5 Delete All Bluetooth Pairing Information

Function Priority

Firmware Upgrades

Voice Prompts

Sidetone

Delete All Bluetooth Pairing Information

A **Delete All Bluetooth Pairing Information** setting can be found in the **Headset Configuration Menu**.

Tap the **Phone Button** when in this menu to **Delete All Bluetooth Pairing Information** stored in the headset.

Access Delete All Pairings in the Configuration Menu

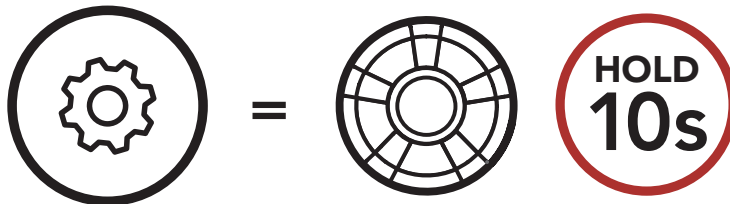

ACCESS CONFIG. MENU

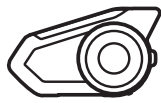

"Configuration menu"

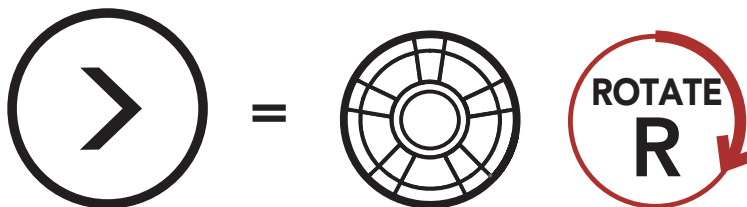

NAVIGATE FORWARD

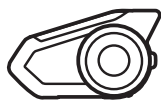

"Delete all pairings"

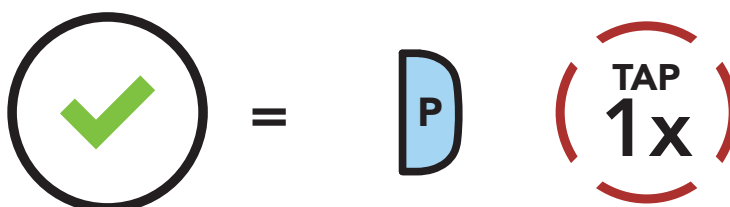

EXECUTE



Pairing with the Remote Control

14. REMOTE CONTROL

You can remotely control the headset using Sena Remote Control devices (sold separately) such as a Handlebar Remote or a Wristband Remote. This eliminates the need to remove your hands from the handlebars for button operations.

14.1 Pairing with the Remote Control

1. Turn on the headset and the Remote Control device.
2. Execute **Remote Control Pairing** in the **Headset Configuration Menu**.

Access Remote Control Pairing in the Configuration Menu

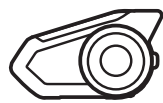
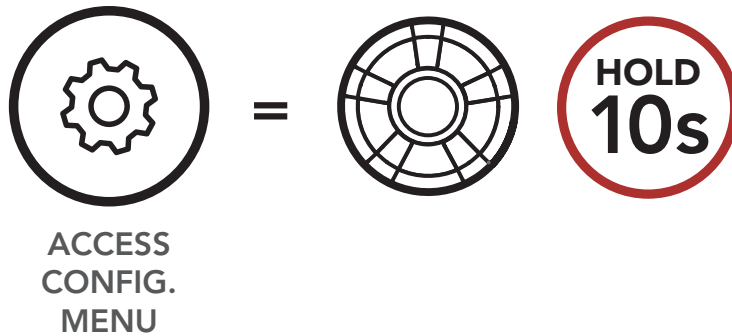

"Configuration menu"

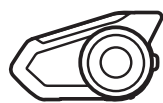
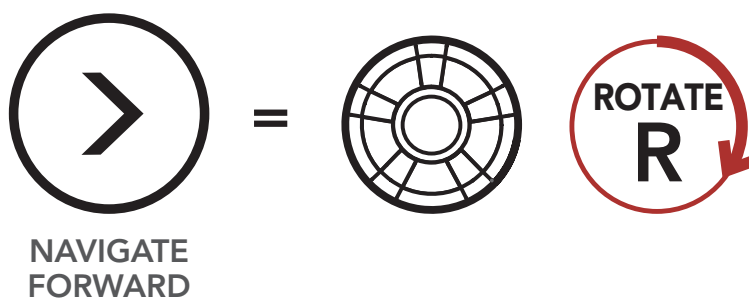

"Remote control pairing"

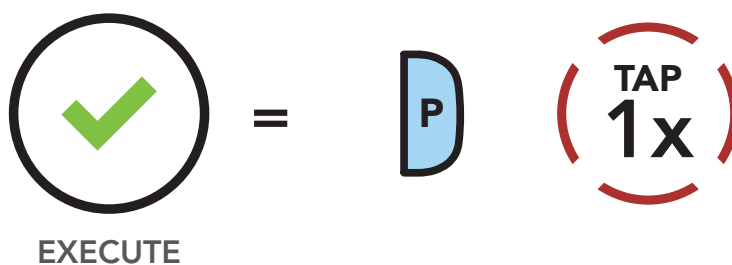



Pairing with the Remote Control

14. REMOTE CONTROL

3. Enter pairing mode in the Remote Control device. The headset will automatically connect with the Remote Control device in pairing mode. You will hear a voice prompt, "**Remote control connected**", when they are successfully paired.

Enter Pairing Mode



=

Enter Pairing Mode on Remote Control.

REMOTE CONTROL

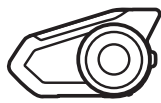

"Remote control connected"



15. TROUBLESHOOTING

Please visit sena.com for answers to frequently asked questions. This detailed online FAQ section deals with troubleshooting, illustrates case studies and contains tips on using the headset.

Fault Reset
Factory Reset

[Click Here to Visit sena.com](http://sena.com)

15.1 Fault Reset

When the headset is not working properly, you can easily reset the unit:

1. Locate the pinhole reset button below on the back of the main unit.
2. Gently insert a paperclip into the hole and tap the **Fault Reset Button** with light pressure.

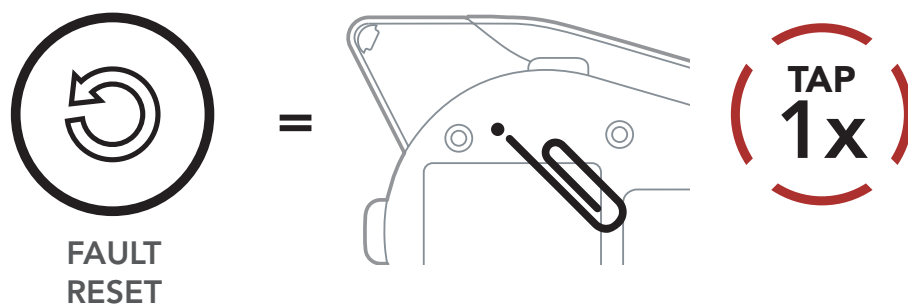

3. The headset will shut down.

Note: Fault Reset will not restore the headset to factory default settings.



15. TROUBLESHOOTING

15.2 Factory Reset

To erase all of your settings and start fresh, the headset can be restored to factory default settings using the **Factory Reset** feature.

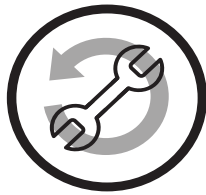

=



FACTORY
RESET



"Factory Reset"

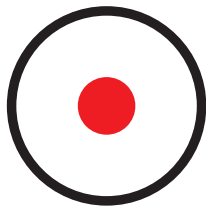

=

Solid red

LED STATUS



=

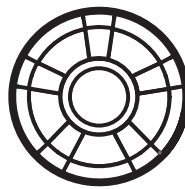

EXECUTE



"Headset reset, good-bye"

Note: If you press the **Phone Button** or don't press the **Jog Dial** within **5 seconds**, the reset attempt is canceled and the headset returns to standby mode. You will hear a voice prompt saying **"Canceled"**.

SENA

Copyright © 2018 Sena Technologies, Inc.
All rights reserved.

© 1998–2018 Sena Technologies, Inc. All rights reserved.

Sena Technologies, Inc. reserves the right to make any changes and improvements to its product without providing prior notice.

Sena™ is a trademark of Sena Technologies, Inc. or its subsidiaries in the USA and other countries. SF1™, SF2™, SF4™, SFR™, SRL™, Momentum™, Momentum INC™, Momentum Lite™, Momentum Pro™, Momentum INC Pro™, Cavalry™, 30K™, 20S EVO™, 20S™, 10S™, 10C™, 10C Pro™, 10U™, 10Upad™, 10R™, 3S™, SMH5™, SMH5-FM™, SMH5 MultiCom™, SMH10™, SMH10R™, SPH10™, SPH10H-FM™, Savage™, Prism Tube WiFi™, Prism Tube™, Prism™, Bluetooth Audio Pack for GoPro®, R1™, RC1™, RC3™, RC4™, Handlebar Remote™, Wristband Remote™, PowerPro Mount™, Powerbank™, FreeWire™, SR10™, SR10i™, SM10™, X1™, X1 Pro™, Expand™, Bluetooth Mic & Intercom™, Tufftalk™, Tufftalk Lite™ are trademarks of Sena Technologies, Inc. or its subsidiaries. These trademarks may not be used without the express permission of Sena.

GoPro® is a registered trademark of Woodman Labs of San Mateo, California. Sena Technologies, Inc. ("Sena") is not affiliated with Woodman Labs, Inc. The Sena Bluetooth Pack for GoPro® is an aftermarket accessory specially designed and manufactured by Sena Technologies, Inc. for the GoPro® Hero3 and Hero4 allowing for Bluetooth capabilities.

The Bluetooth® word mark and logos are owned by the Bluetooth SIG, Inc. and any use of such marks by Sena is under license. iPhone® and iPod® touch are registered trademarks of Apple Inc.

Address: 3150 Almaden Expresay,
Suite 238 San Jose, CA 95118